

Muebles de guardado y de apoyo. Libreros, Gabinetes, Lockers, Estantes y Credenzas.

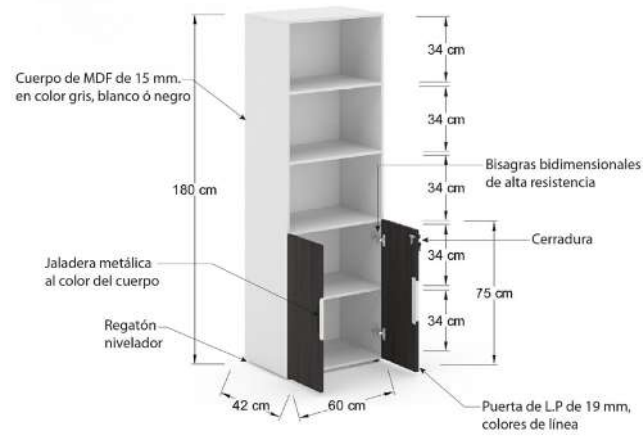

Índice:

Libreros económicos en MDF	1 - 3
Libreros en x	4 - 7
Libreros Metrik's	8 - 9
Libreros Metálicos sin puertas y con puertas con 40 cm de profundidad	10 - 12
Libreros sobre cubierta en L.P. sin puertas	13 - 14
Libreros sobre cubierta en L.P. con puertas	15 - 16
Libreros sobre cubierta 19mm	17 -
Libreros sobre cubierta con puerta retráctil 19mm	18 -
Libreros sobre cubierta Metrik's	
Libreros abiertos para mampara	
Librero para mampara con puerta retráctil	
Gabinetes metálicos	
Locker económico MDF	
Locker económico metálico, cuerpo y puertas en un solo color	
Locker metálico, cuerpo un color, puertas en varios colores	
Anaqueles, estantes económico paquete	
Anaqueles estantes, estandar paquete poste calibre 14, entrepaño calibre 22	
85 x 30 x 220 de 4 y 5 entrepaños	
85 x 45 x 220 de 4 y 5 entrepaños	
85 x 60 x 220 de 4 y 5 entrepaños	
Poste y entrepaños individuales metálicos	
Anaqueles metálicos de ensamble, entrepaño en MDF con melamina	
81 x 41 x 152 de 4 entrepaños	
121 x 41 x 152 de 4 entrepaños	
121 x 41 x 183 de 5 entrepaños (3+2)	
Anaqueles metálicos de ensamble, entrepaños MDF natural	
81 x 41 x 183 de 5 entrepaños	
81 x 41 x 152 de 4 entrepaños	
121 x 41 x 152 de 4 entrepaños	
121 x 41 x 183 de 5 entrepaños	
Credenzas auxiliares	

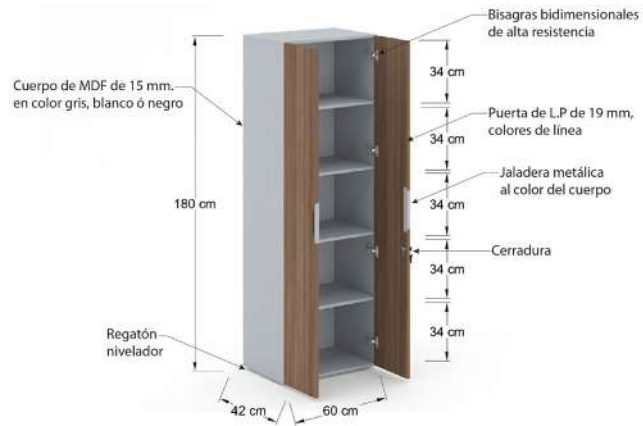
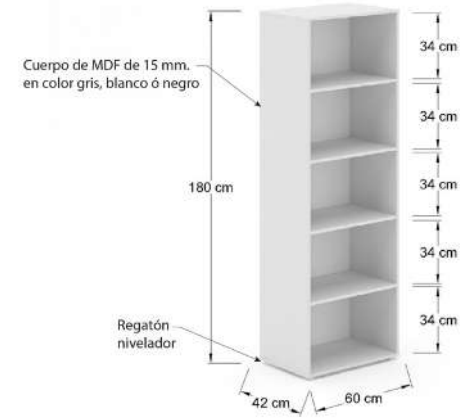
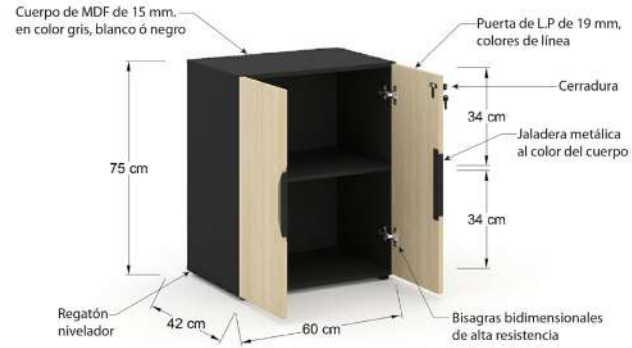
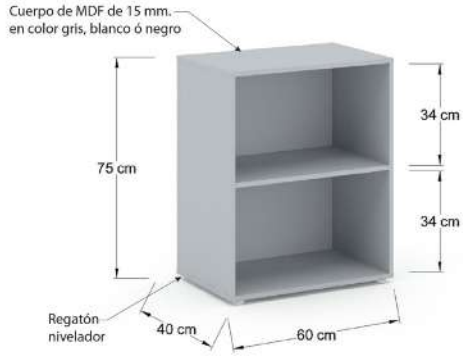

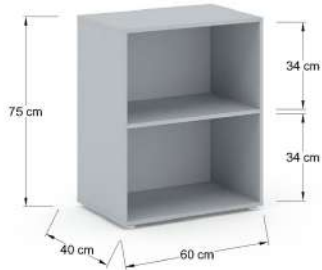

LAMF75

Librero abierto de un entrepaño, cuerpo fabricado en MDF de 15mm en color gris, blanco ó negro, incluye regatones para nivelar. Medida 60x40x75 cm.

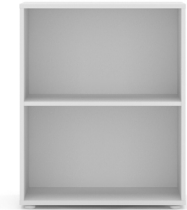
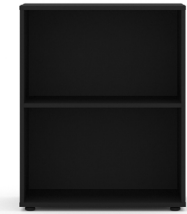
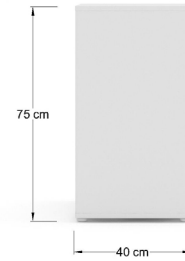
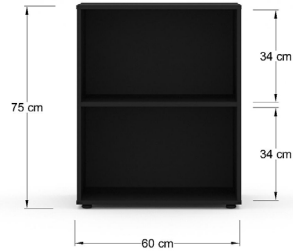

LPMF75

Librero de un entrepaño con puertas, cuerpo fabricado en MDF de 15mm en color gris, blanco ó negro, puertas en L.P. 19 mm color a elegir, incluye jaladera metálica, cerradura y regatones para nivelar. Medida 60x42x75 cm.

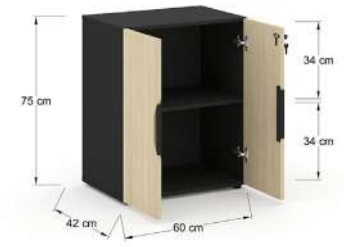

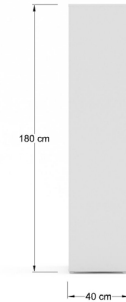
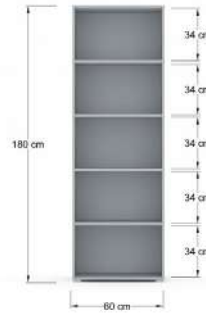
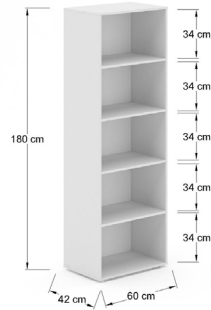

LAMF18

Librero abierto de cuatro entrepaños, cuerpo fabricado en MDF de 15mm en color gris, blanco ó negro, incluye regatones para nivelar. Medida 60x42x180 cm.

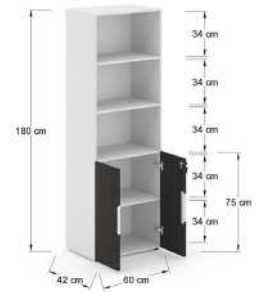
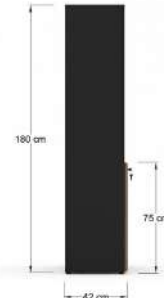
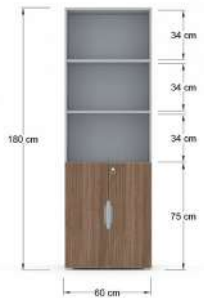

LMMF18

Librero de cuatro entrepaños con puertas bajas, cuerpo fabricado en MDF de 15mm en color gris, blanco o negro, puertas en L.P. 19mm color a elegir, incluye jaladera metálica, cerradura y regatones para nivelar para nivelar. Medida 60x42x180 cm.

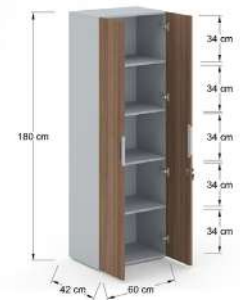

LPMF18

Librero de cuatro entrepaños con puertas completas, cuerpo fabricado en MDF de 15mm en color gris, blanco o negro, puertas en L.P. 19mm color a elegir, incluye jaladera metálica, cerradura y regatones para nivelar para nivelar. Medida 60x42x180 cm.



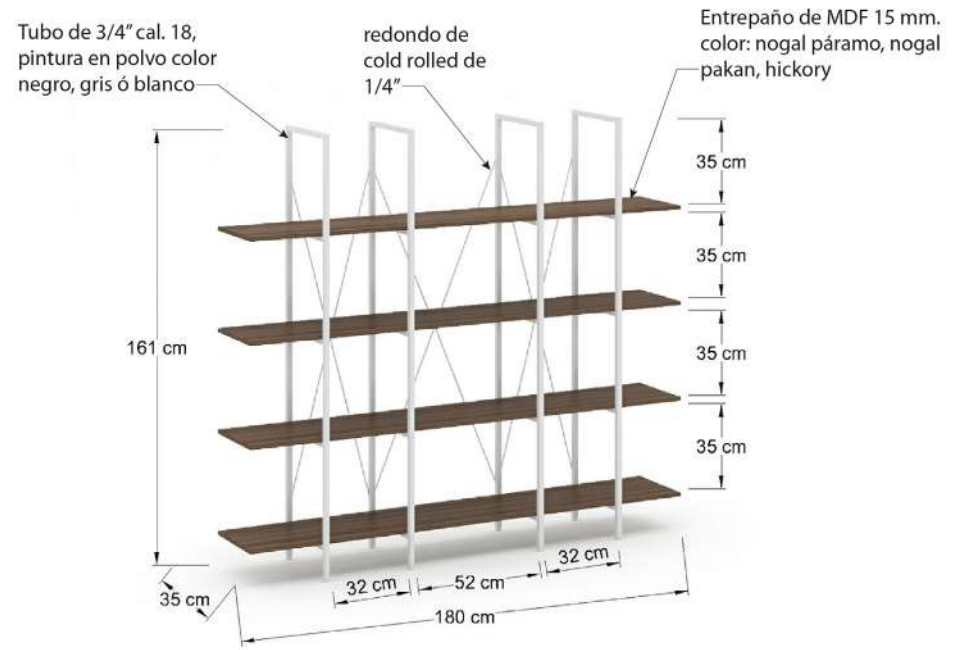
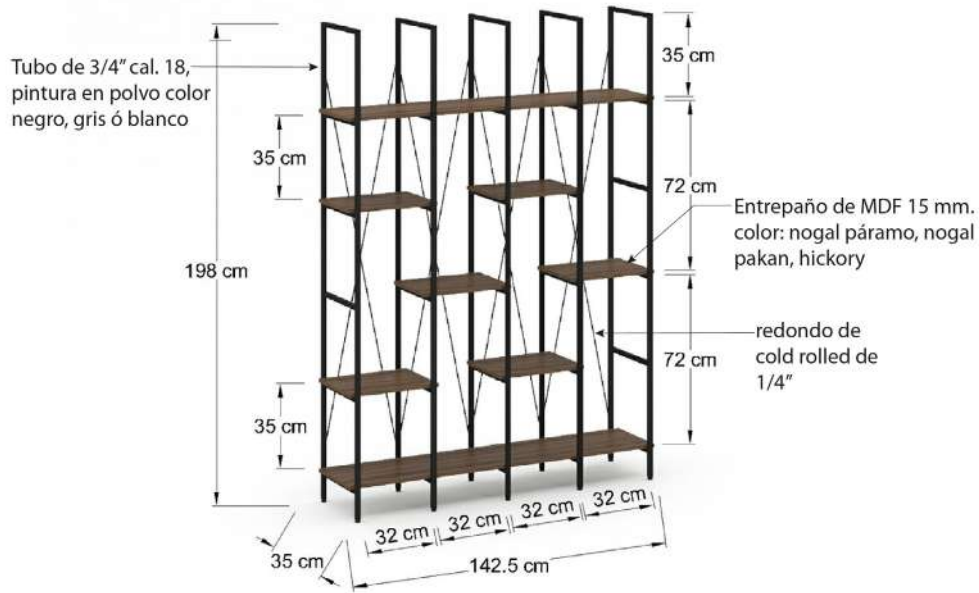



NS80

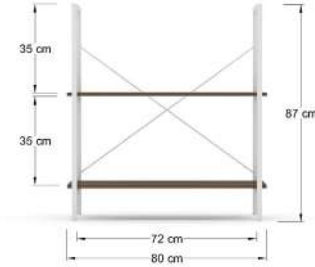
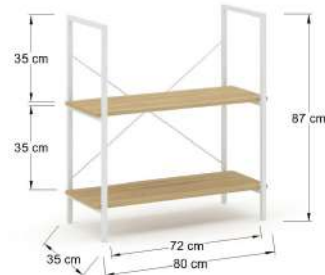

Librero de 2 entrepaños en mdf 15 mm., estructura metálica, tubular cuadrado de 3/4" y cruceta en redondo de 1/4".



NS40

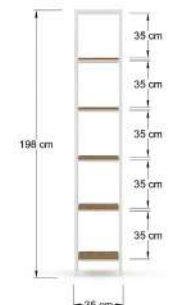
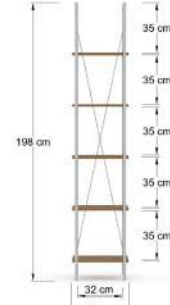
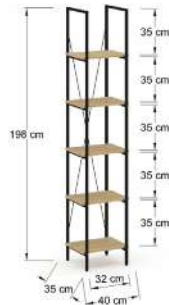

Librero de 5 entrepaños en mdf 15 mm., estructura metálica, tubular cuadrado de 3/4" y cruceta en redondo de 1/4".



NS60B

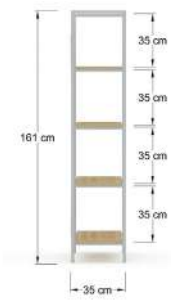
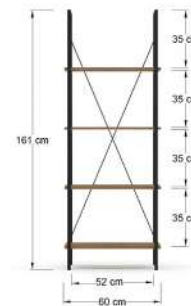

Librero de 4 entrepaños en mdf 15 mm., estructura metálica, tubular cuadrado de 3/4" y cruceta en redondo de 1/4".



NS60A

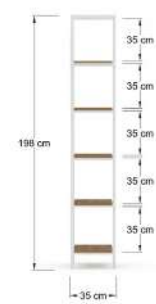
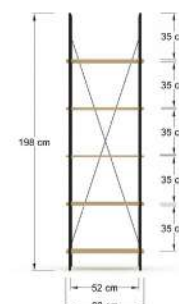

Librero de 5 entrepaños en mdf 15 mm., estructura metálica, tubular cuadrado de 3/4" y cruceta en redondo de 1/4".

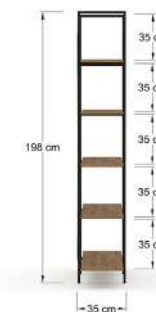
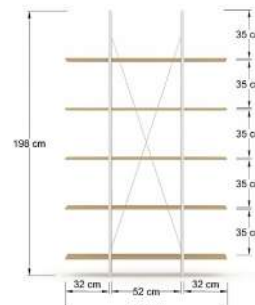
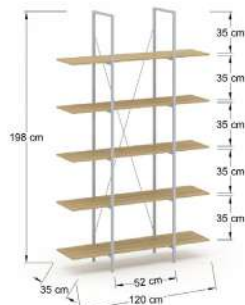

NS120 Librero de 5 entrepaños en mdf 15 mm., estructura metálica, tubular cuadrado de 3/4" y cruceta en redondo de 1/4".

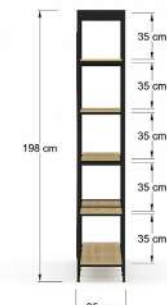
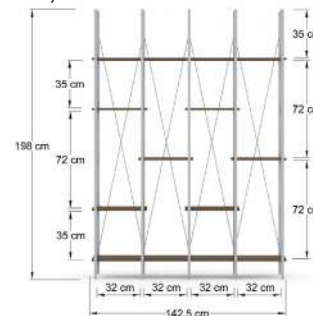
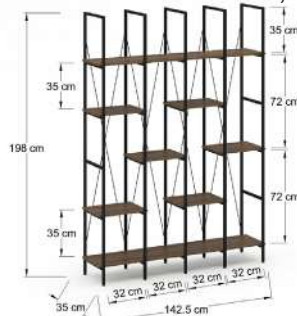

NS142 Librero de 4 entrepaños en mdf 15 mm., estructura metálica, tubular cuadrado de 3/4" y cruceta en redondo de 1/4".

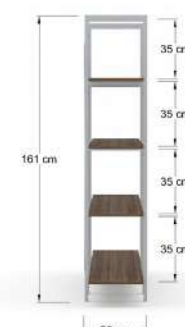
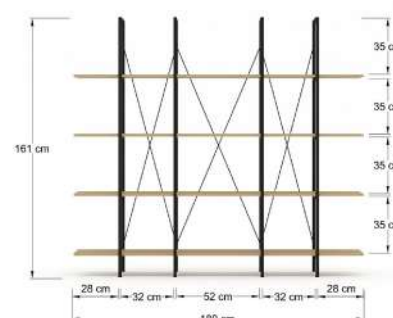
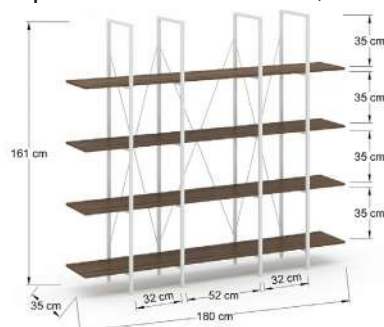

NS180 Librero de 4 entrepaños en mdf 15 mm., estructura metálica, tubular cuadrado de 3/4" y cruceta en redondo de 1/4".



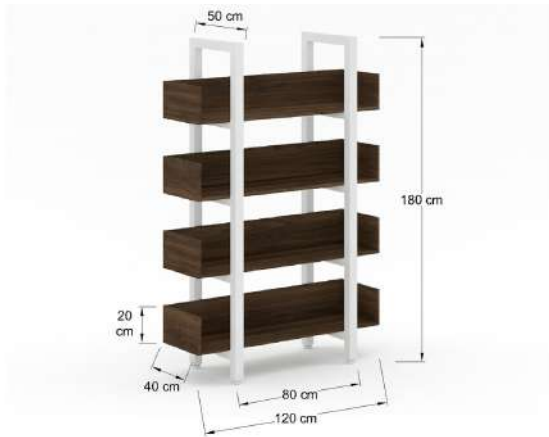
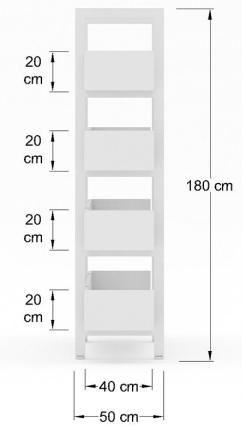
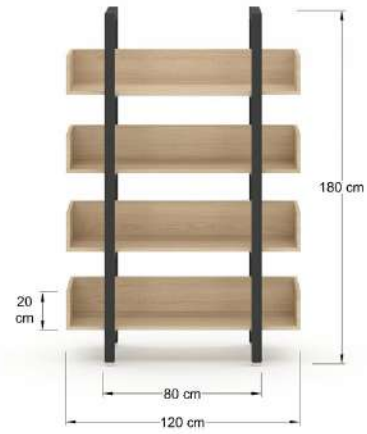
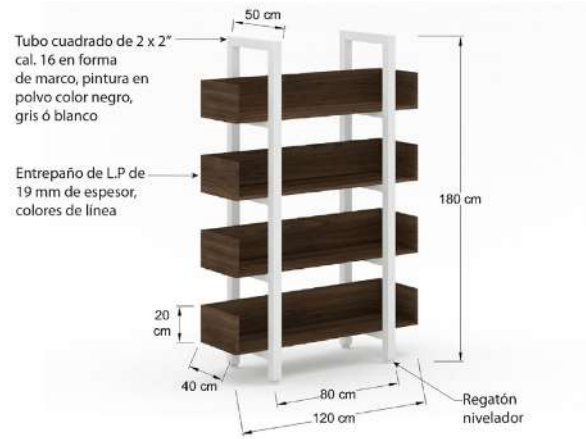



LVMTK120

Librero de piso de 120 x40 x180. Cuerpo en estructura metálica color a elegir blanco, negro ó gris. con 4 entrepaños color a elegir.

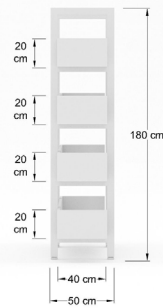

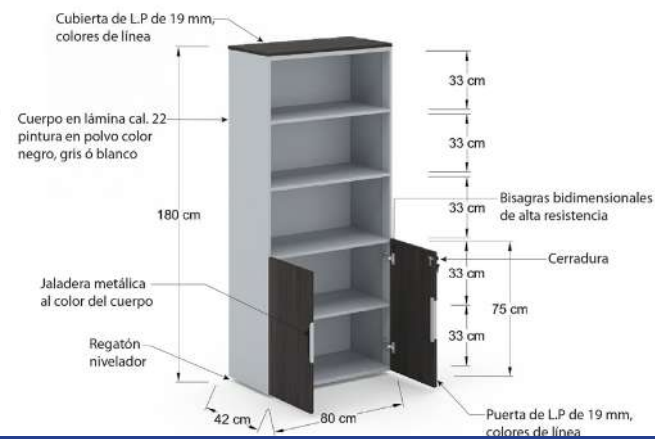
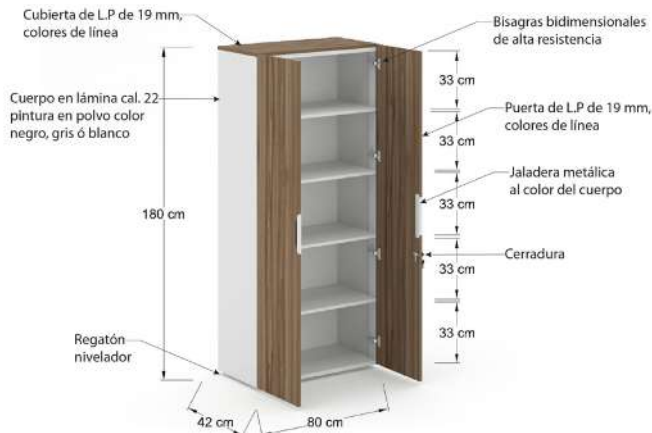
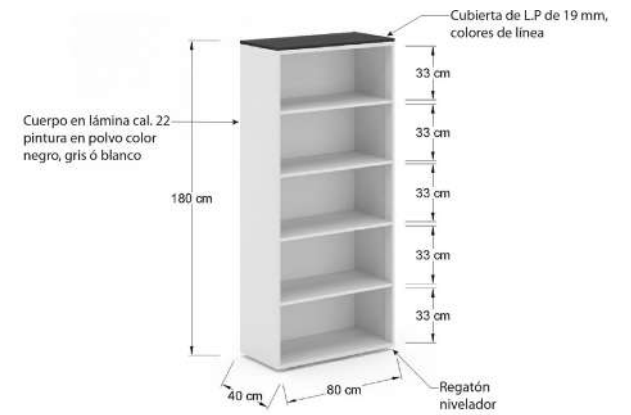
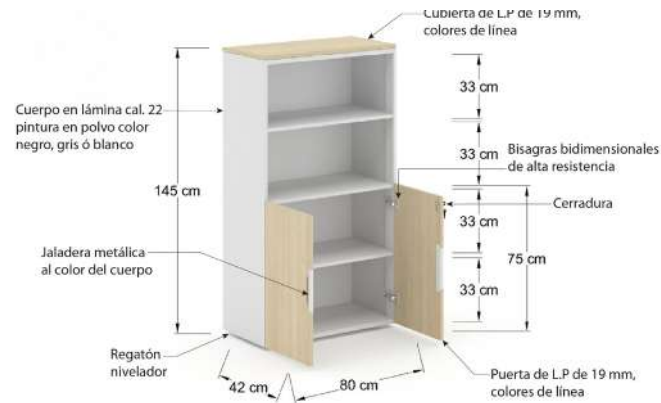
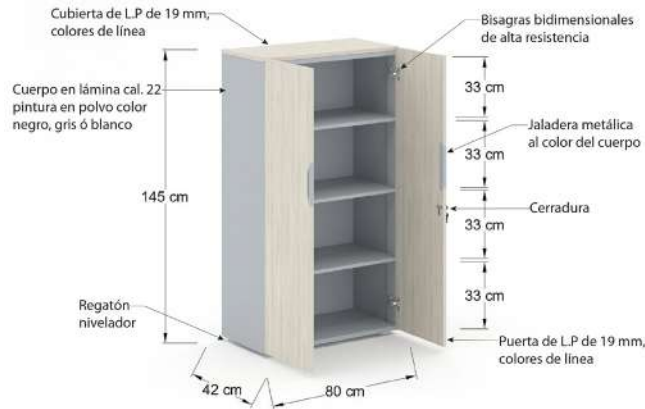
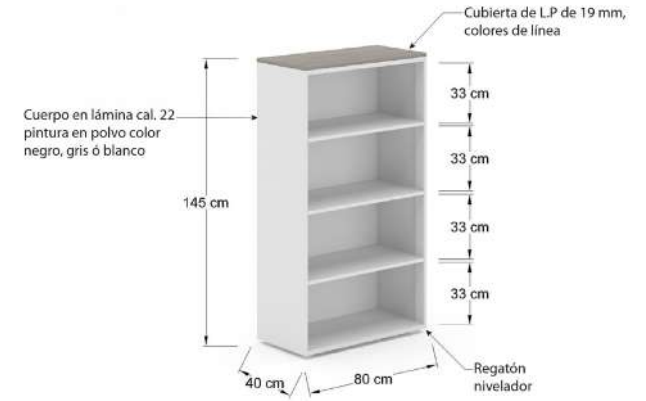
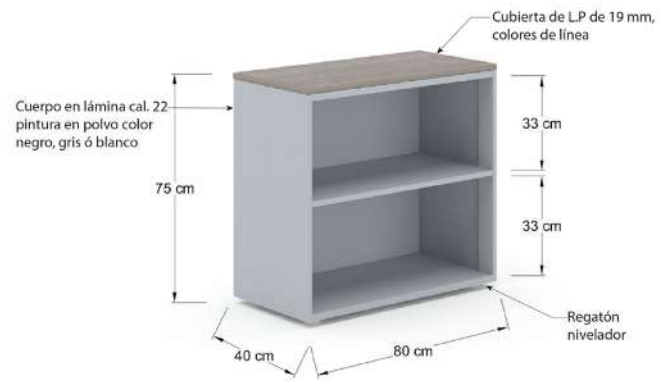

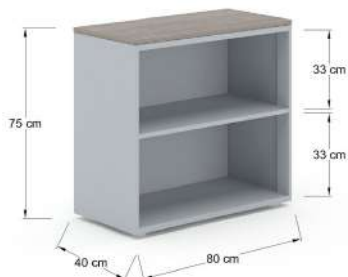

L1MS4

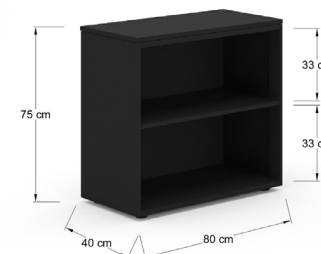
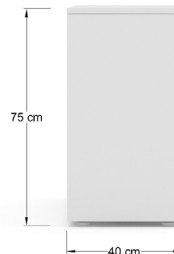
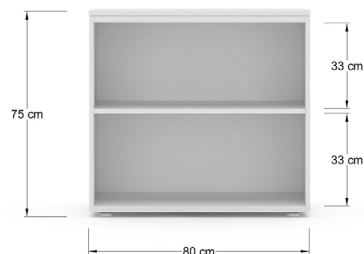

Librero metálico con 1 entreaño de 80X40X75 cm.

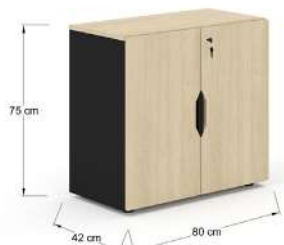

L1ML74

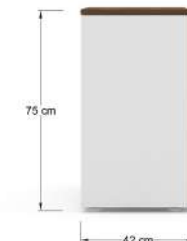
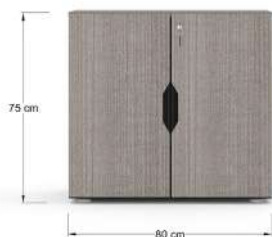

Librero metálico con 1 entreaño de 80x42x75 cm. con puertas y cubierta en L.P. incluye chapa.

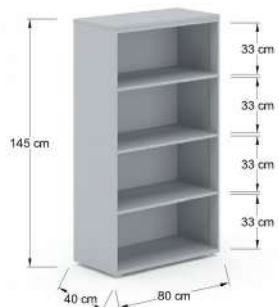

L3MS4

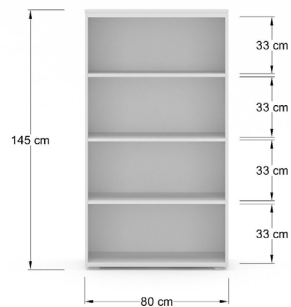

Librero metálico con 3 entreaños de 80x40x145 cm. y cubierta en L.P.



L3ML74

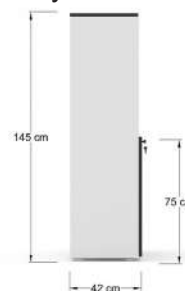

Librero metálico con 3 entreaños de 80x42x145 cm. con puertas inferiores. y cubierta en l.p. incluye chapa.



L3ML144

Librero metálico con 3 entreaños de 80x42x145 cm. con puertas y cubierta en L.P. incluye chapa.

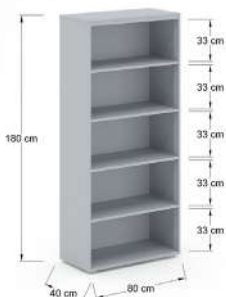
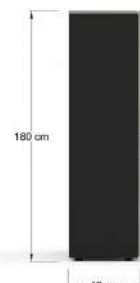

L4MS4

Librero metálico con 4 entreaños, de 80x40x180 cm. y cubierta en L.P.

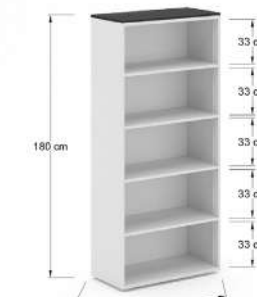
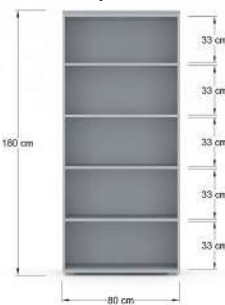

L4ML74

Librero metálico con 4 entreaños de 80x42x180 cm. con puertas inferiores y cubierta en L.P. incluye chapa.

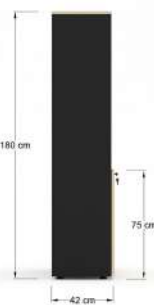

L4ML174

Librero metálico con 4 entreaños de 80x42x180 cm. con 2 puertas y cubierta en L.P. incluye chapa.



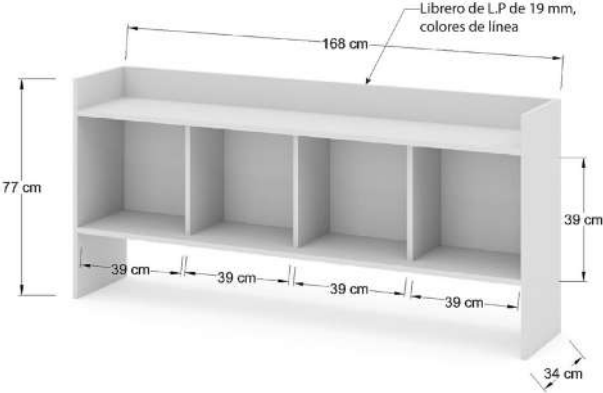
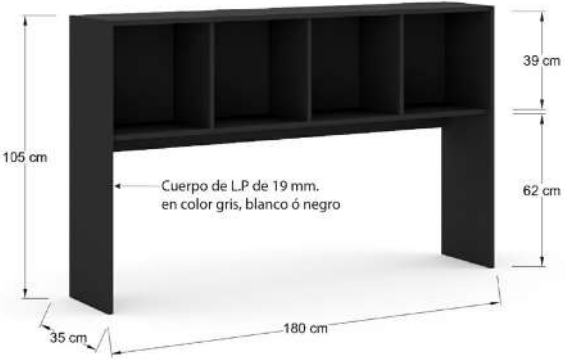
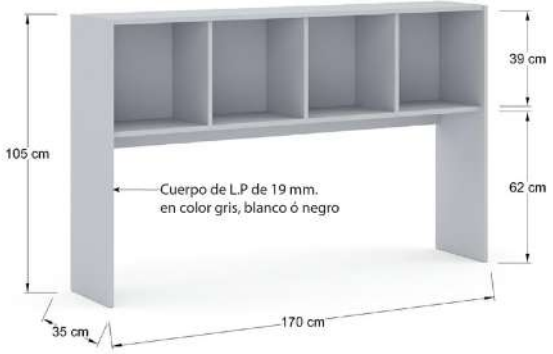
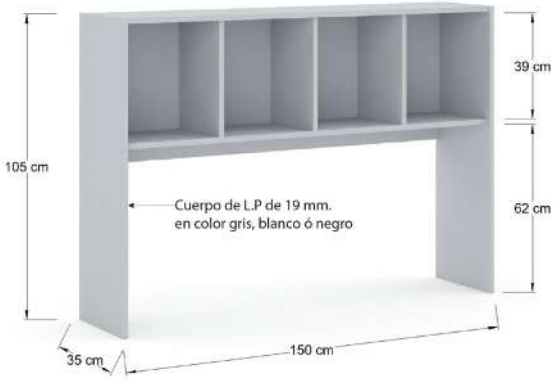
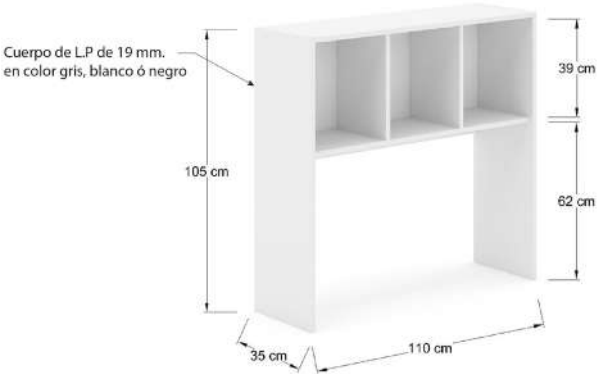

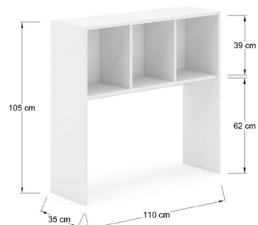

ALBR1035 Librero abierto fabricado en laminado pástico 19mm, con 3 nichos, sin forro en la parte baja. Para credenza de 120 cm.

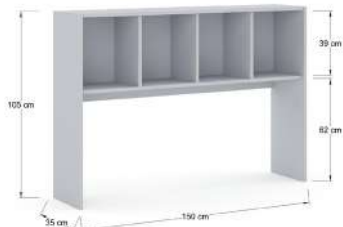
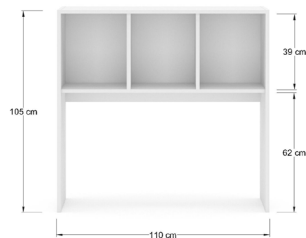

ALBR1535 Librero abierto fabricado en laminado pástico 19mm, con 4 nichos, sin forro en la parte baja. Para credenza de 160 cm.

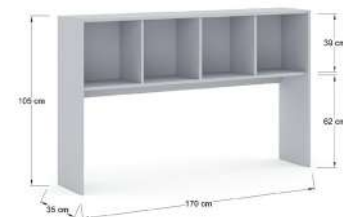
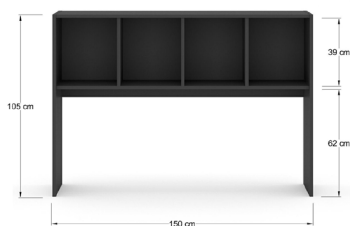

ALBR1735 Librero abierto fabricado en laminado pástico 19mm, con 4 nichos, sin forro en la parte baja. Para credenza de 180 cm.

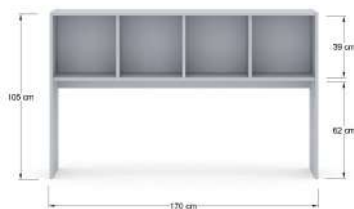

ALBR1835 Librero abierto fabricado en laminado pástico 19mm, con 4 nichos, sin forro en la parte baja. Para credenza de 190 cm.

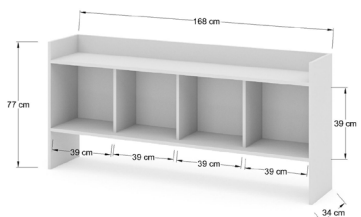

EXLB1634 Librero abierto fabricado en laminado pástico 19mm, con 4 nichos, sin forro en la parte baja.

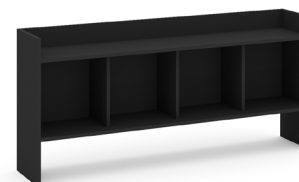
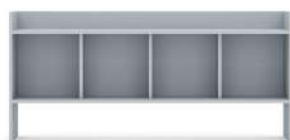

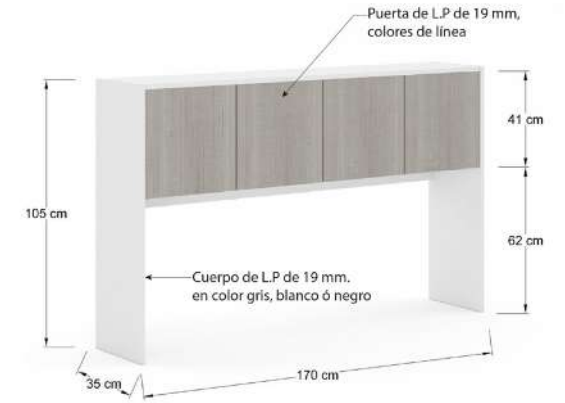
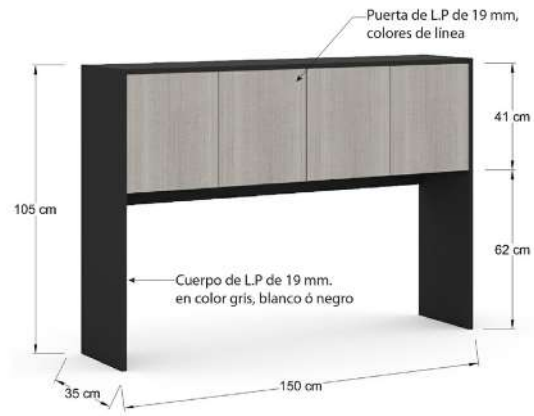
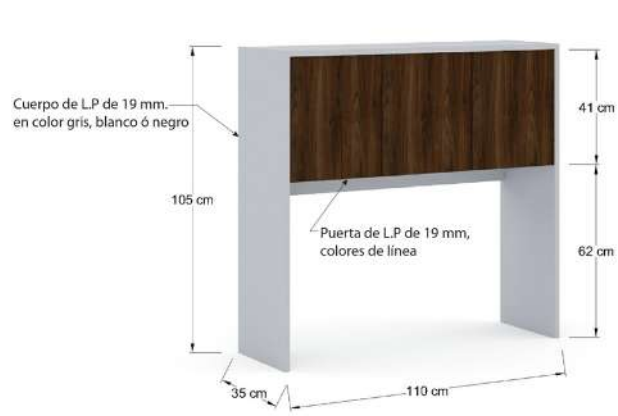



LBR1035

Librero sobre credenza con puertas abatibles fabricado en laminado plástico 19mm, con 3 nichos, sin forro en la parte baja. Para credenza de 120 cm.



LBR1535

Librero sobre credenza con puertas abatibles fabricado en laminado plástico 19mm, con 4 nichos, sin forro en la parte baja. Para credenza de 160 cm.

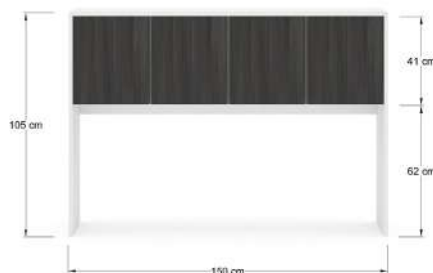

LBR1735

Librero sobre credenza con puertas abatibles fabricado en laminado plástico 19mm, con 4 nichos, sin forro en la parte baja. Para credenza de 180 cm.

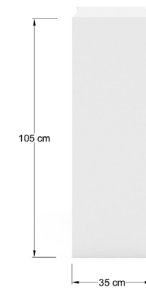
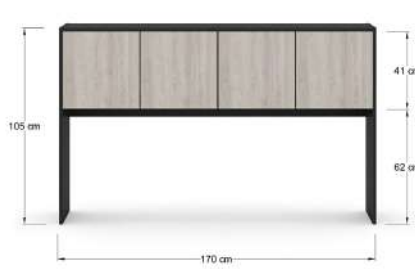

LBR1835

Librero sobre credenza con puertas abatibles fabricado en laminado plástico 19mm, con 4 nichos, sin forro en la parte baja. Para credenza de 190 cm.

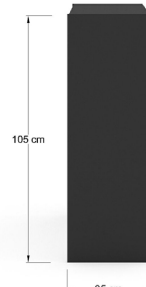

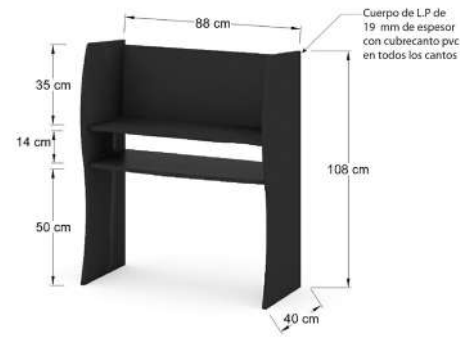
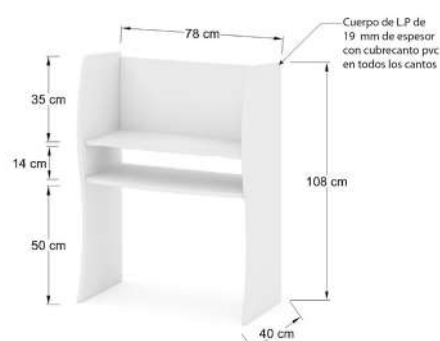
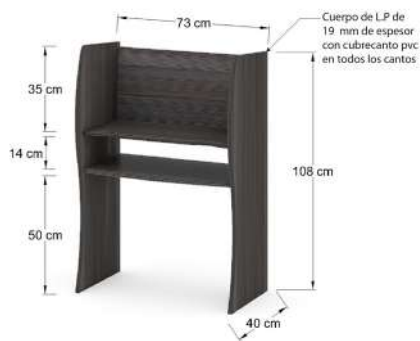
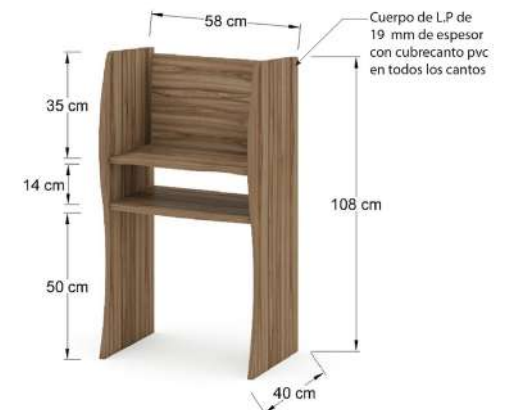
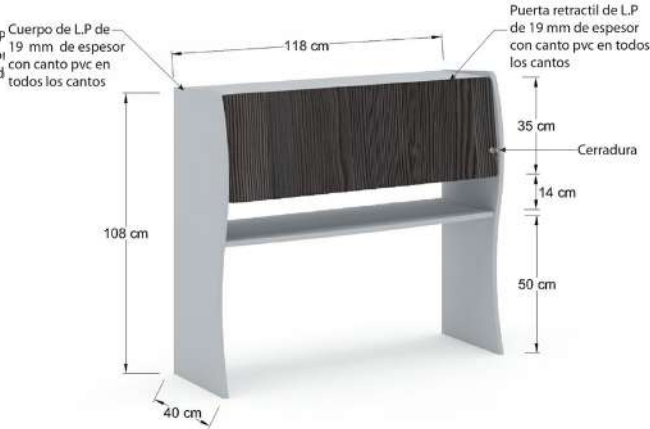
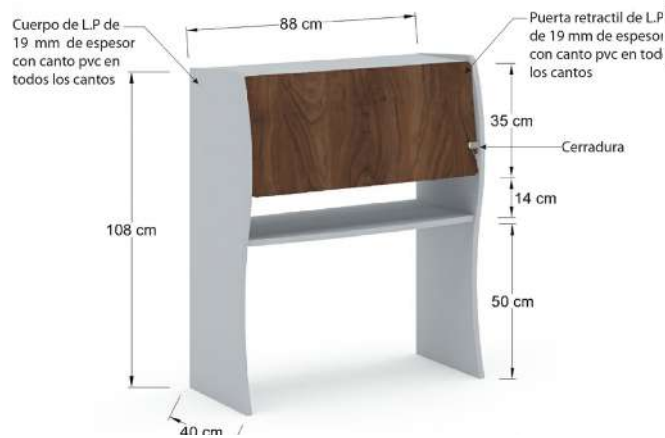
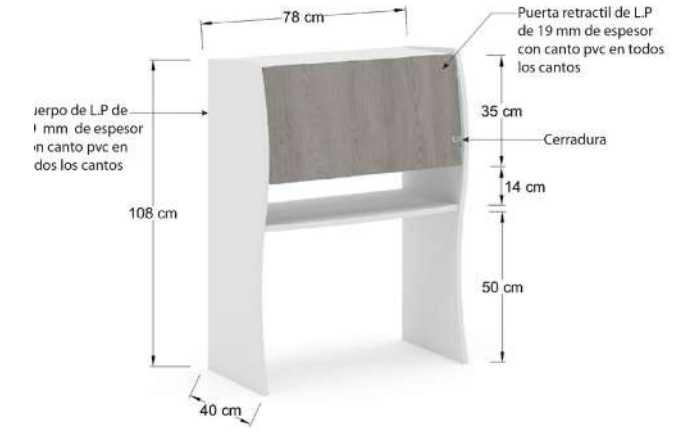
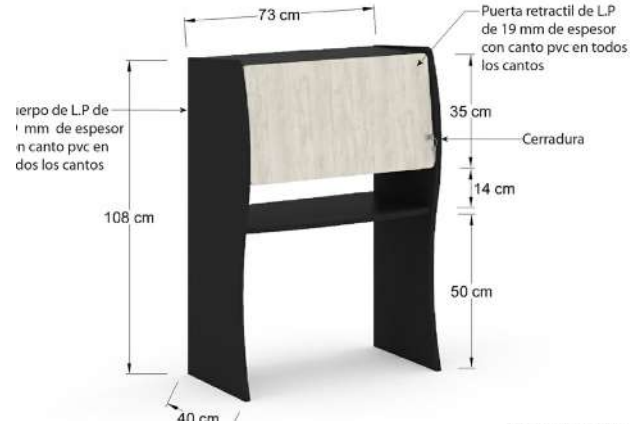
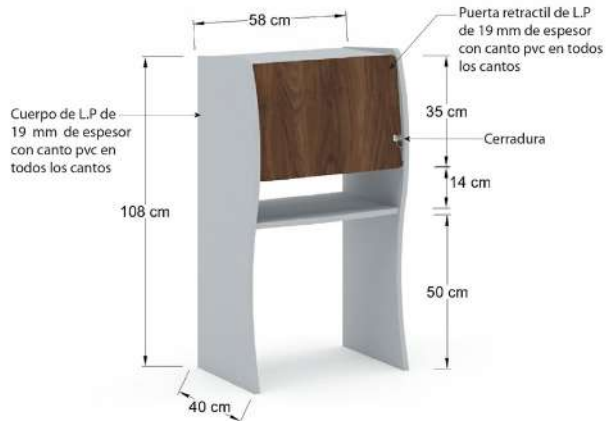



LSA60

Librero sobre cubierta abierto, medidas:58 x 40 x108 cm.



LSA75

Librero sobre cubierta abierto, medidas:73 x 40 x108 cm.

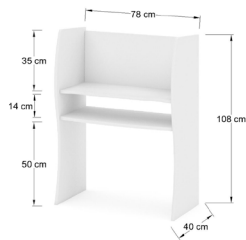

LSA80

Librero sobre cubierta abierto, medidas:78 x 40 x108 cm.

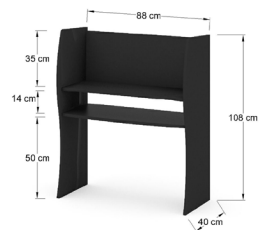

LSA90

Librero sobre cubierta abierto, medidas:88 x 40 x108 cm.

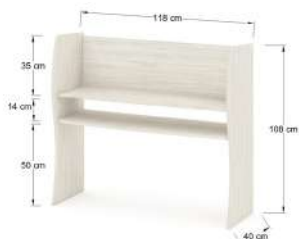

LSA120

Librero sobre cubierta abierto, medidas:118 x 40 x108 cm.





LSC60

Librero sobre cubierta con puerta retráctil, medidas:58 x 40 x108 cm.



LSC75

Librero sobre cubierta con puerta retráctil, medidas:73 x 40 x108 cm.



LSC80

Librero sobre cubierta con puerta retráctil, medidas:78 x 40 x108 cm.

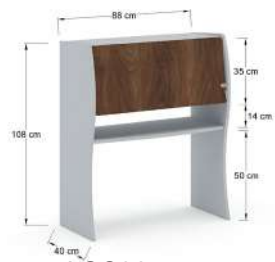

LSC90

Librero sobre cubierta con puerta retráctil, medidas:88 x 40 x108 cm.



LSC120

Librero sobre cubierta con puerta retráctil, medidas:118 x 40 x108 cm.



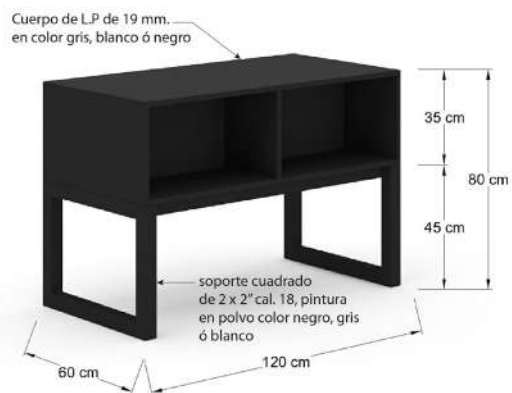
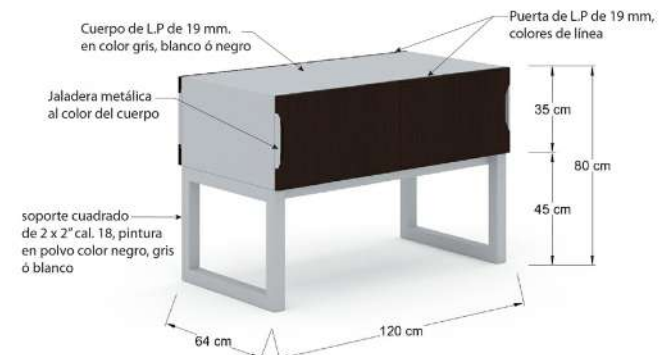
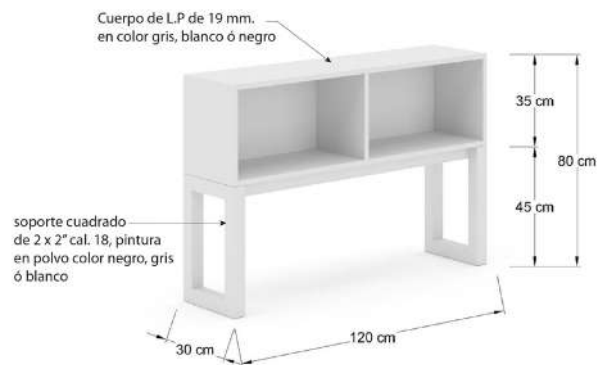
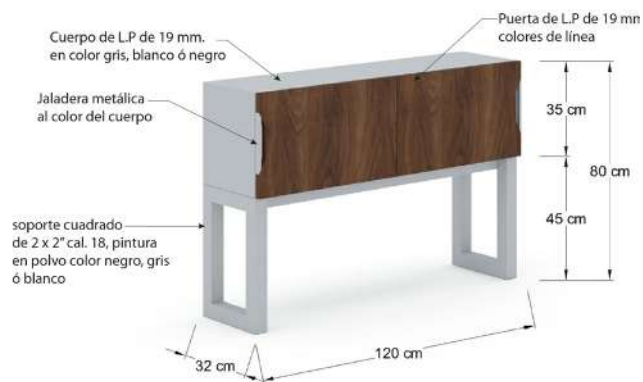



MKLP123

Librero individual con puertas en 19mm de espesor.

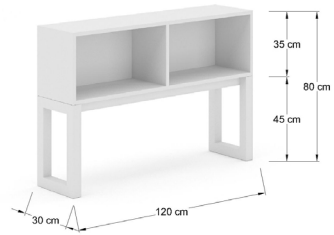

MKES123

Librero individual sin puertas.

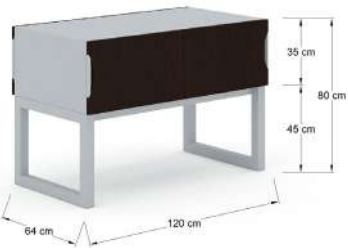
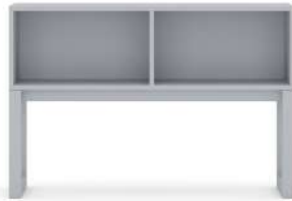

MKLP126

Librero individual con puertas en 19mm de espesor.

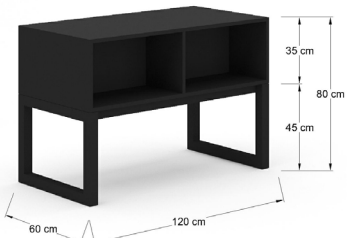

MKES123

Librero individual sin puertas.

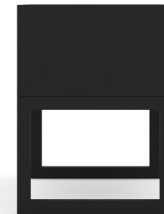
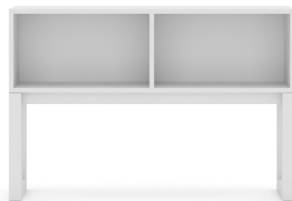

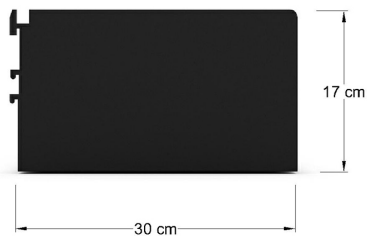
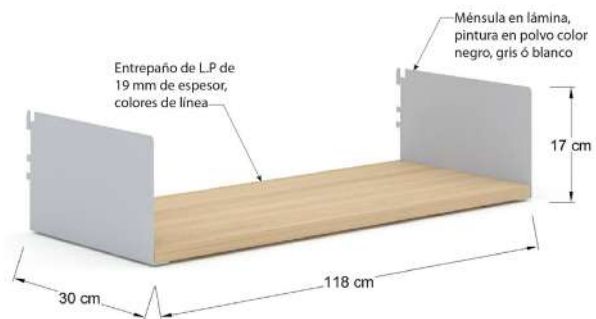
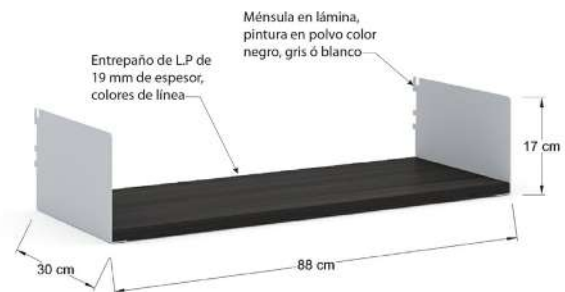
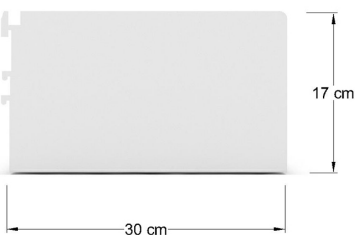
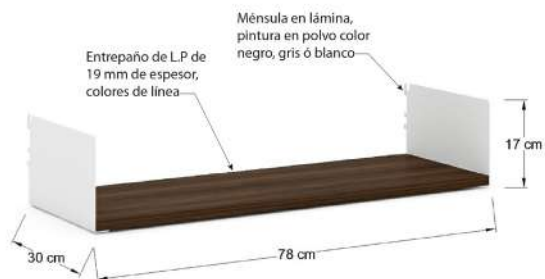
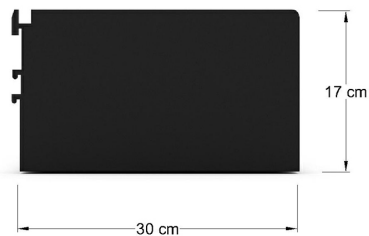
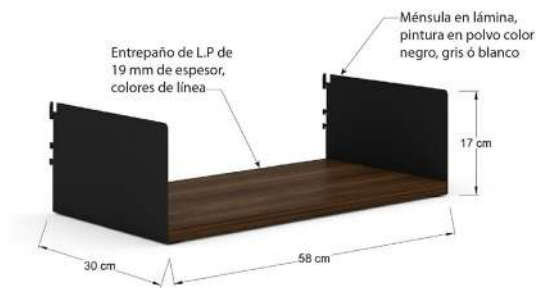

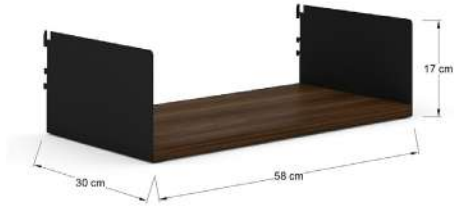

LEA60

Entrepáño para mampara fabricado en L.P. de 19mm.

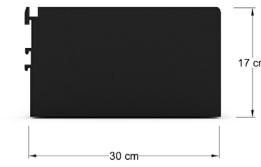
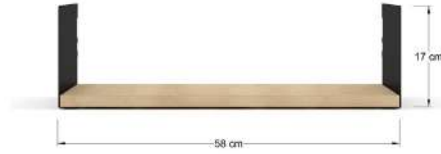

LEA75

Entrepáño para mampara fabricado en L.P. de 19mm.

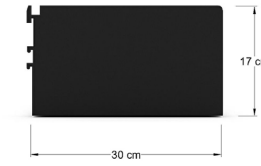

LEA80

Entrepáño para mampara fabricado en L.P. de 19mm.

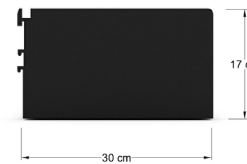
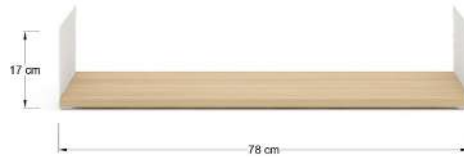

LEA90

Entrepáño para mampara fabricado en L.P. de 19mm.

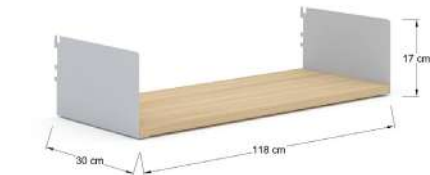
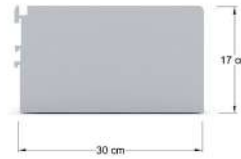
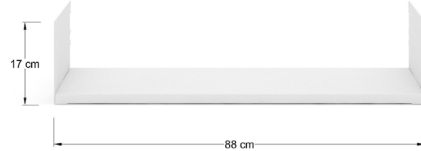

LEA120

Entrepáño para mampara fabricado en L.P. de 19mm.

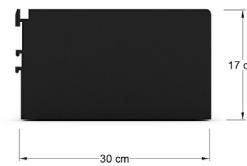

Librero para mampara con puerta retráctil

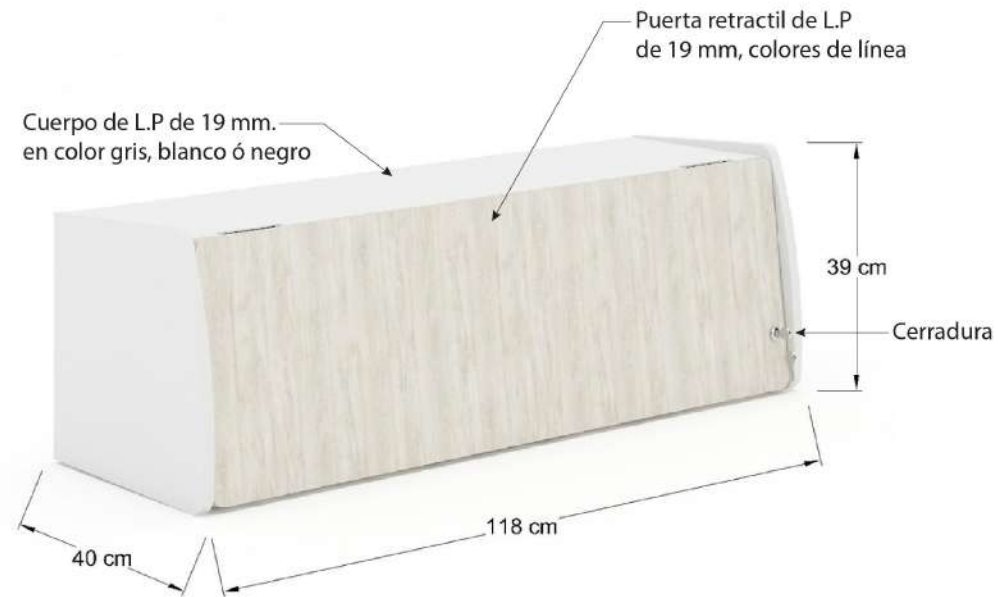
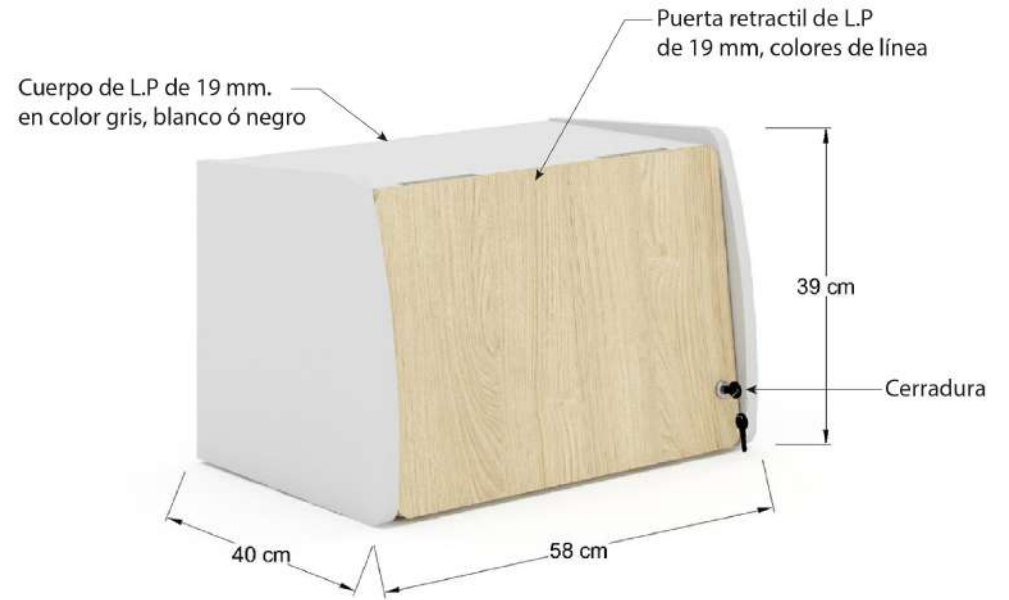

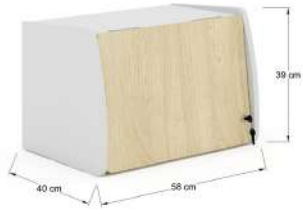

LRC60

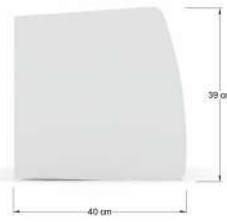

Librero con puerta retráctil de 58x40x39 cm para mampara, mensulas por separado.



LRC75

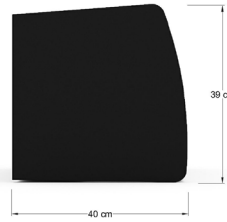

Librero con puerta retráctil de 73x40x39 cm para mampara, mensulas por separado.



LRC80

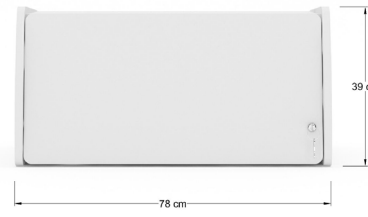

Librero con puerta retráctil de 78x40x39 cm para mampara, mensulas por separado.



LRC90

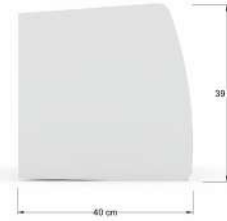
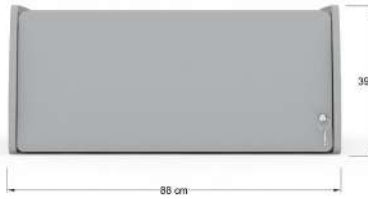

Librero con puerta retráctil de 88x40x39 cm para mampara, mensulas por separado.



LRC120



Librero con puerta retráctil de 118x40x39 cm para mampara, mensulas por separado.

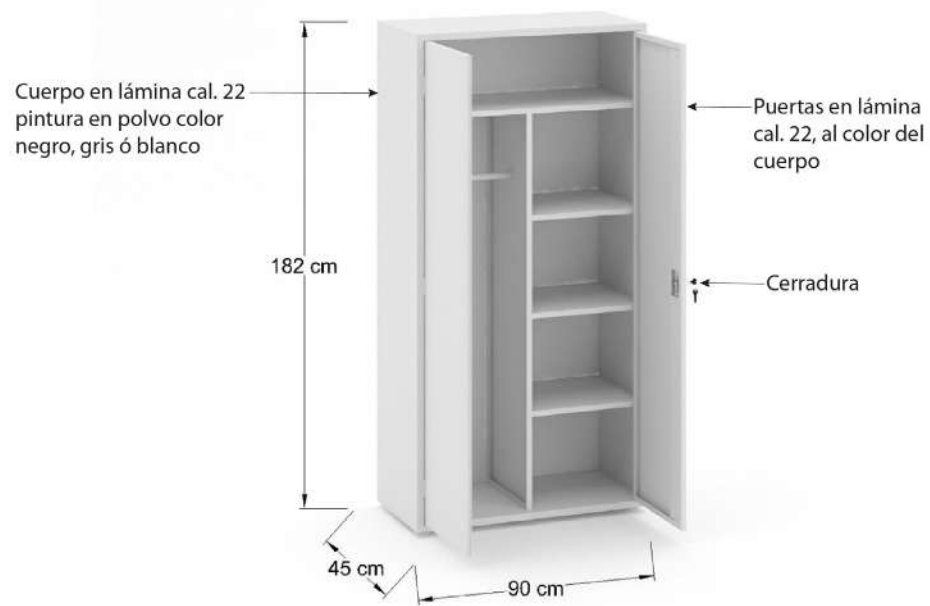
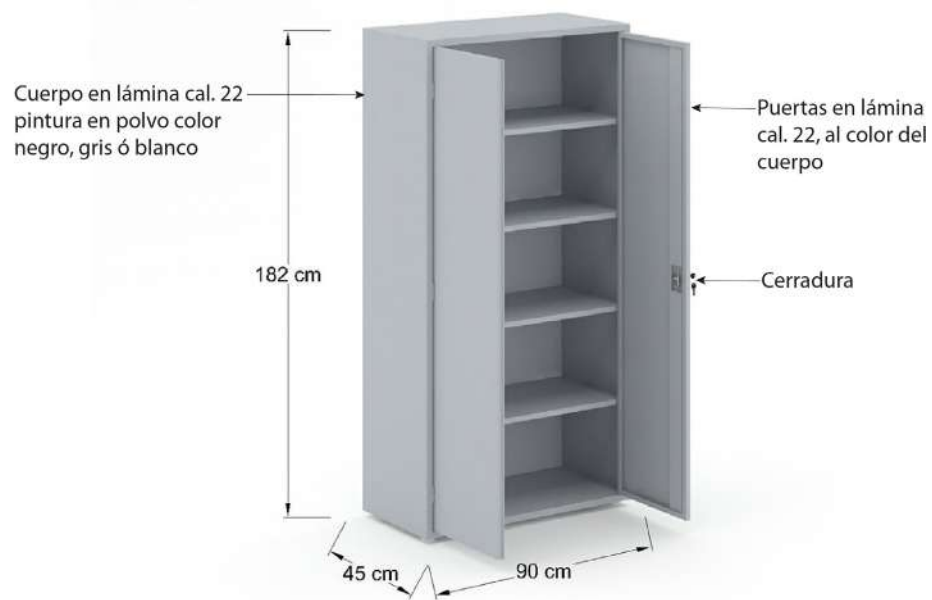



B180U

Gabinete universal grande de 90 de frente x45 de fondo x182cm de alto, con cuatro entrepaños, dos puertas, fabricadas en lámina cal. 22.

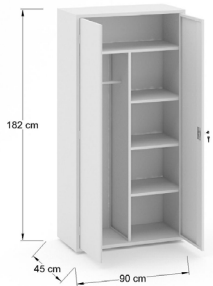
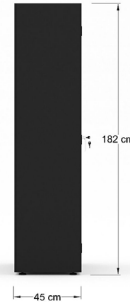

B180G

Gabinete universal grande de 90 de frente x45 de fondo x182cm de alto, tipo guardarropa, con cuatro entrepaños, dos puertas, fabricado en en lámina cal. 22.

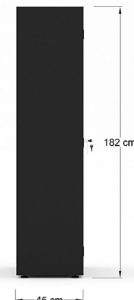
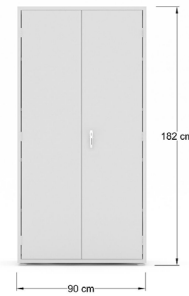

Locker económico MDF

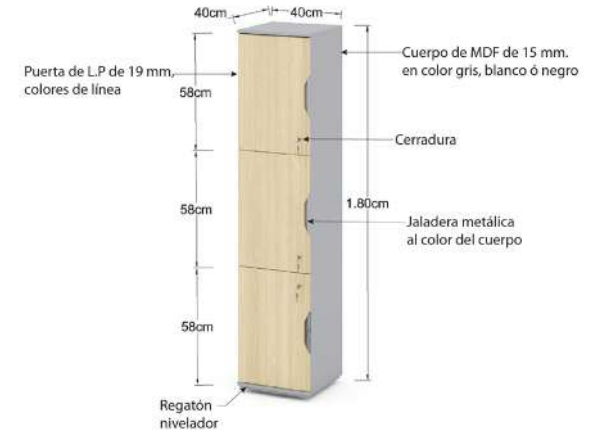
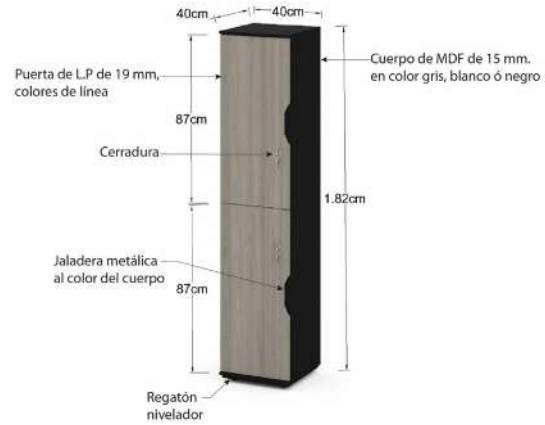
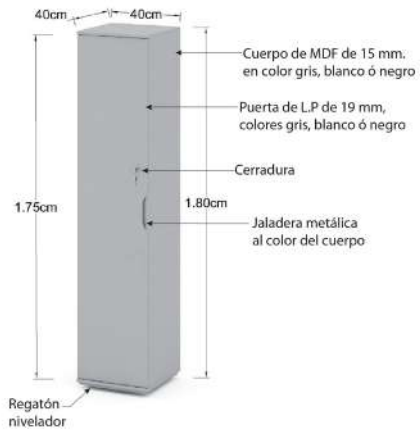

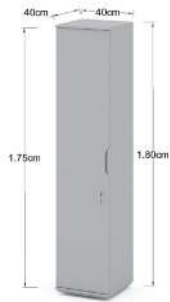

LKDF1

Locker en cuerpo de MDF de 15mm color negro, gris o blanco, con 1 puerta de L.P. 19mm en colores de línea, incluye cerradura, jaladera y regatones para nivelar.

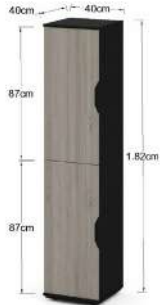

LKDF2

Locker en cuerpo de MDF de 15mm color negro, gris o blanco, con 2 puertas de L.P. 19mm en colores de línea, incluye cerradura y jaladera por puerta y regatones para nivelar.

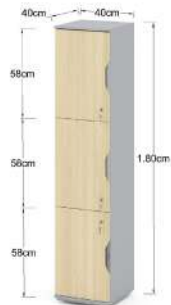

LKDF3

Locker en cuerpo de MDF de 15mm color negro, gris o blanco, con 3 puertas de L.P. 19mm en colores de línea, incluye cerradura y jaladera por puerta y regatones para nivelar.

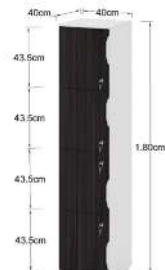

LKDF4

Locker en cuerpo de MDF de 15mm color negro, gris o blanco, con 4 puertas de L.P. 19mm en colores de línea, incluye cerradura y jaladera por puerta y regatones para nivelar.



Locker económico metálico, cuerpo y puertas en un solo color

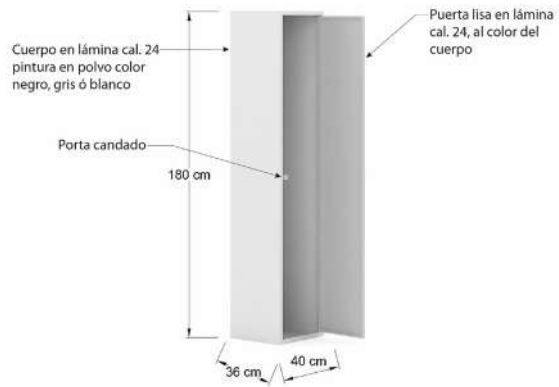
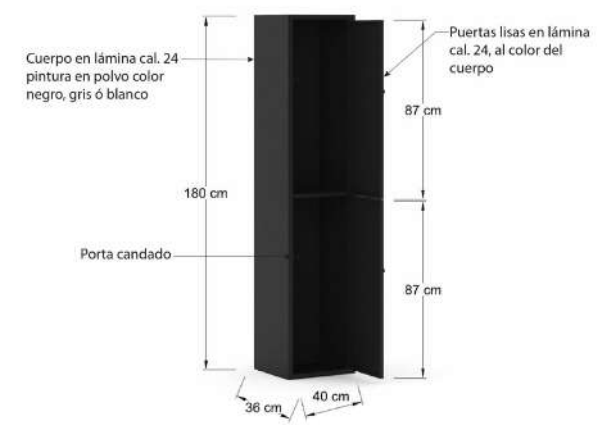
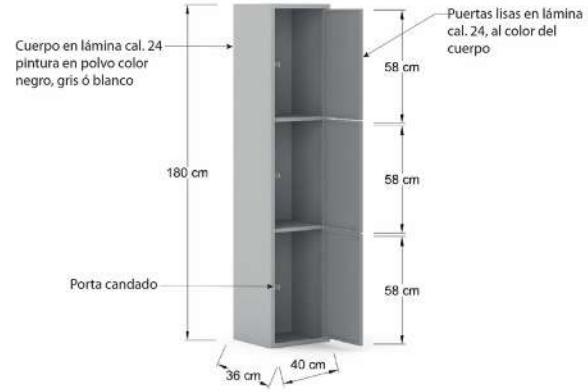
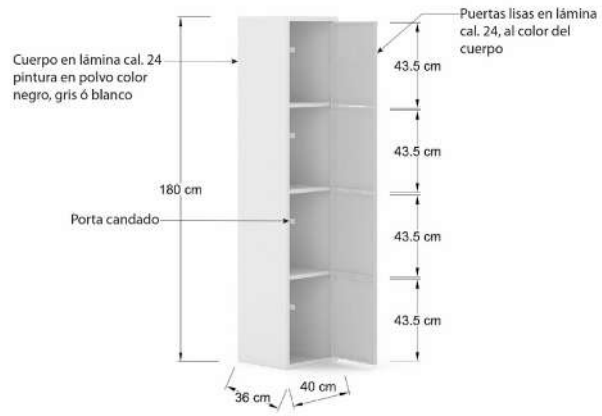

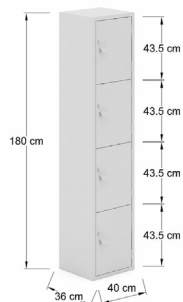

LCK4PP

Locker metálico de 4 puertas de 40 de frente x 36 de fondo x180cm de alto, fabricado en lámina de acero, puerta lisa con porta candado, cuerpo color gris, negro, blanco.

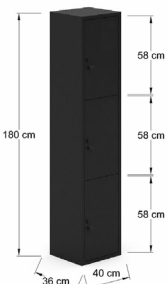
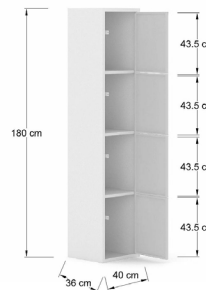
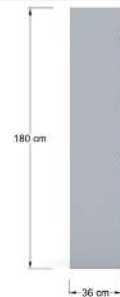
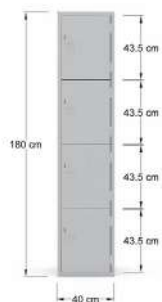

LCK3PP

Locker metálico de 3 puertas de 40 de frente x 36 de fondo x180cm de alto, fabricado en lámina de acero, puerta lisa con porta candado, cuerpo color gris, negro, blanco.

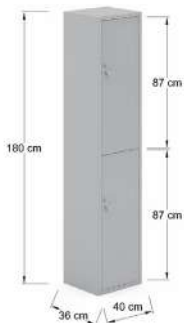
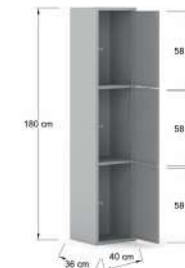
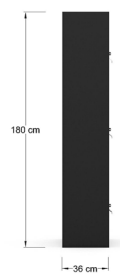
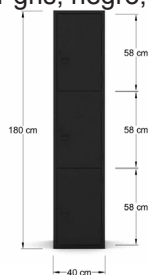

LCK2PP

Locker metálico de 2 puertas de 40 de frente x 36 de fondo x180cm de alto, fabricado en lámina de acero, puerta lisa con porta candado cuerpo color gris, negro, blanco.

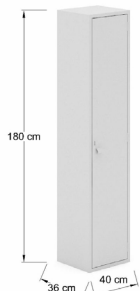
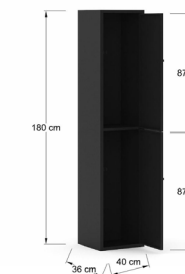
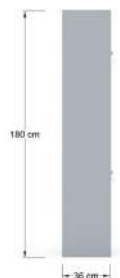
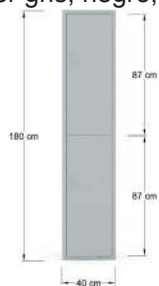

LCK1PP

Locker metálico de 1 puerta de 40 de frente x 36 de fondo x180cm de alto, fabricado en lámina de acero, puerta lisa con porta candado cuerpo color gris, negro, blanco.

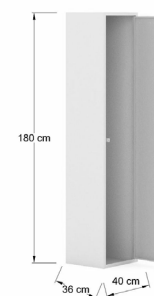
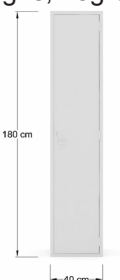

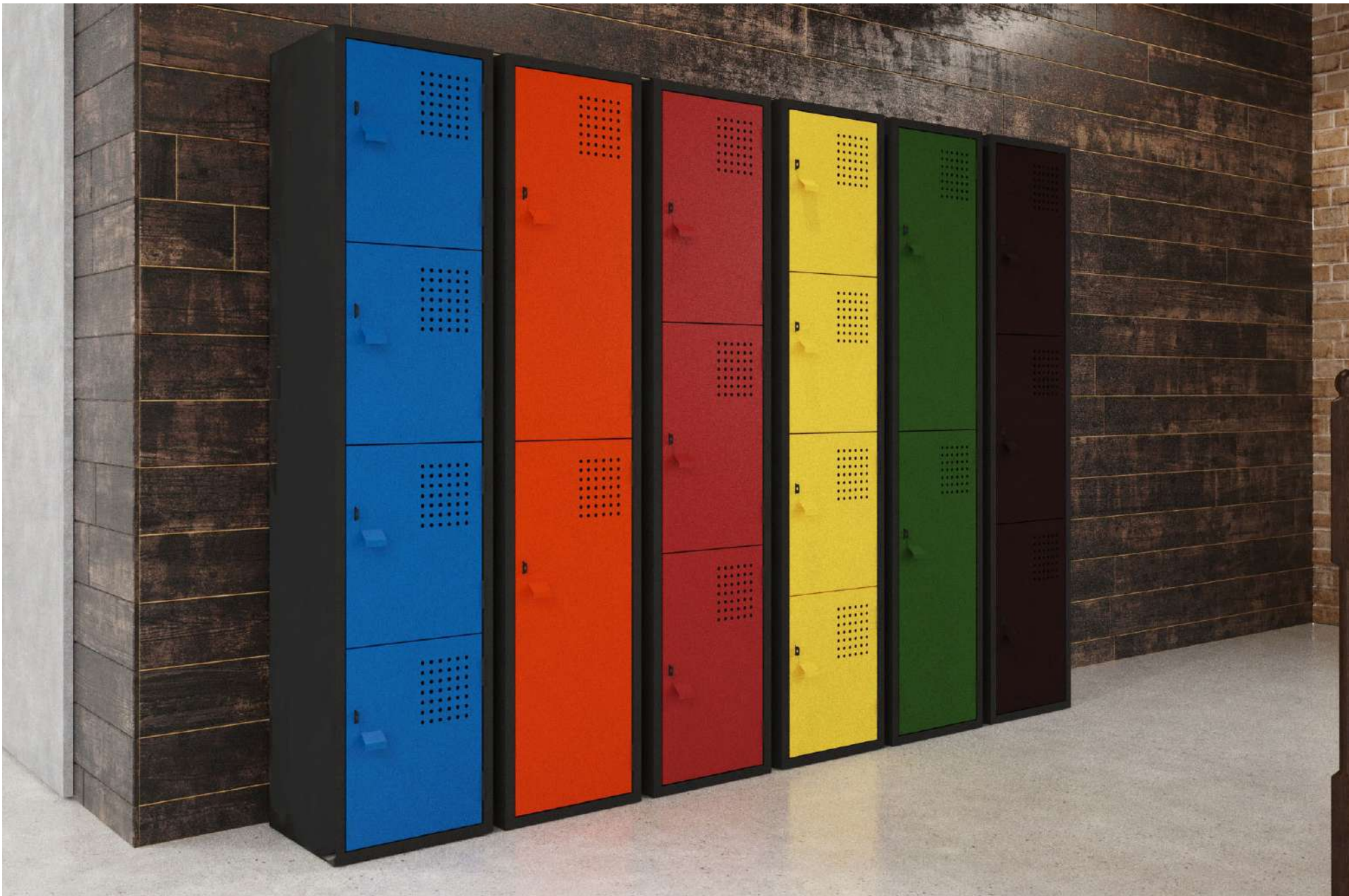

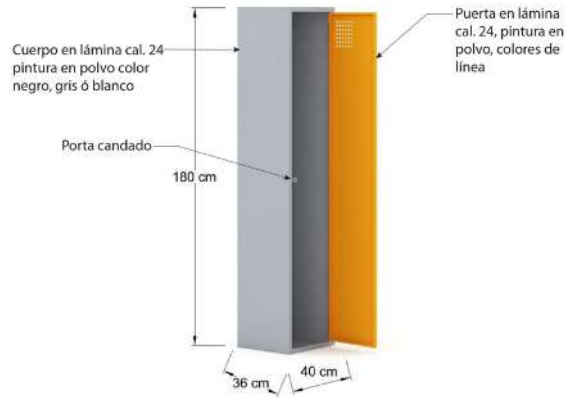
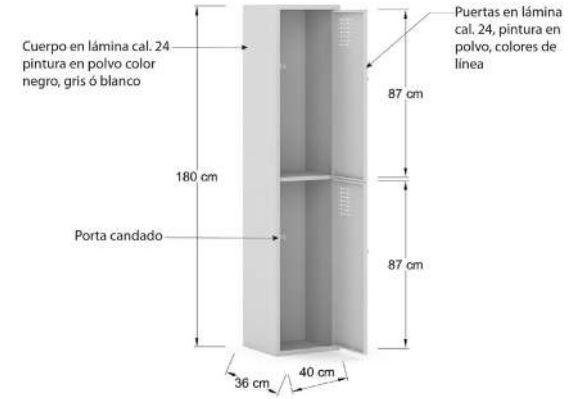
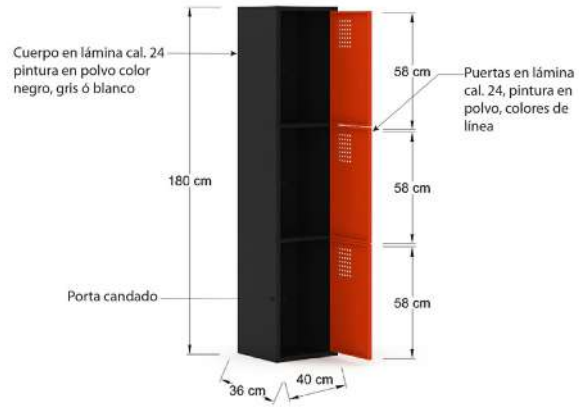
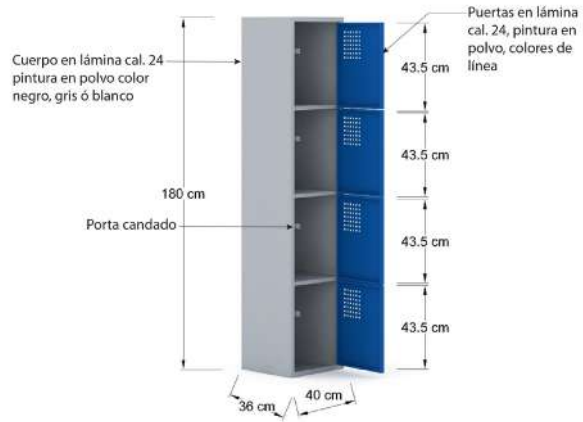





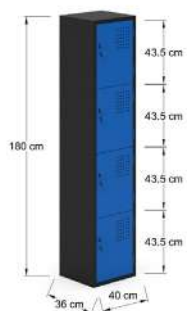

LCK4PP-C

Locker metálico de 4 puertas de 40 de frente x 36 de fondo x180cm de alto, fab. en lámina de acero, puerta con rejilla decorativa y porta candado cuerpo color gris, negro, blanco puertas perforadas en color a elegir.

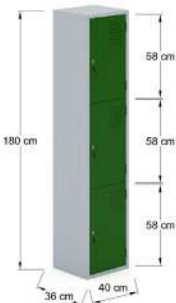

LCK3PP-C

Locker metálico de 3 puertas de 40 de frente x 36 de fondo x180cm de alto, fab. en lámina de acero, puerta con rejilla decorativa y porta candado cuerpo color gris, negro, blanco puertas perforadas en color a elegir.

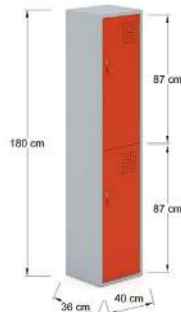

LCK2PP-C

Locker metálico de 2 puertas de 40 de frente x 36 de fondo x180cm de alto, fab. en lámina de acero, puerta con rejilla decorativa y porta candado cuerpo color gris, negro, blanco puertas perforadas en color a elegir.

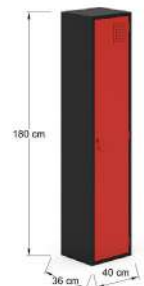

LCK1PP-C

Locker metálico de 1 puertas de 40 de frente x 36 de fondo x180cm de alto, fab. en lámina de acero, puerta con rejilla decorativa y porta candado cuerpo color gris, negro, blanco puertas perforadas en color a elegir.

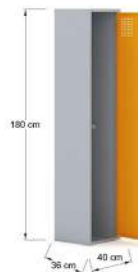
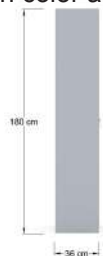
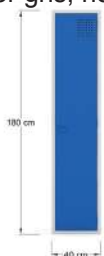
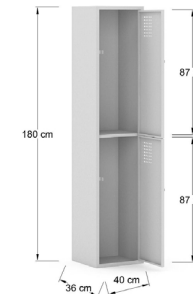
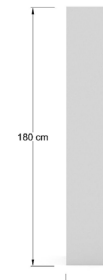
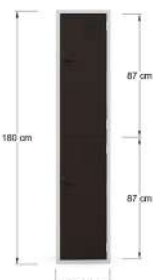
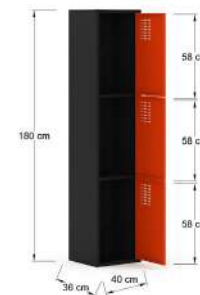
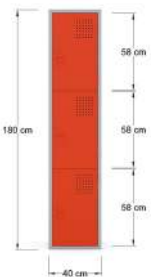
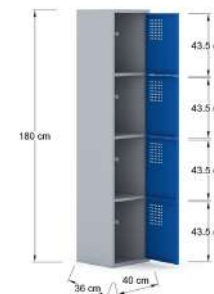
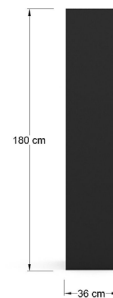
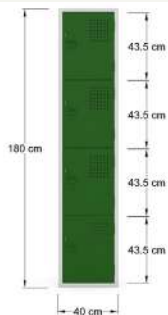



Capacidad de carga de 50 kg por entrepaño.

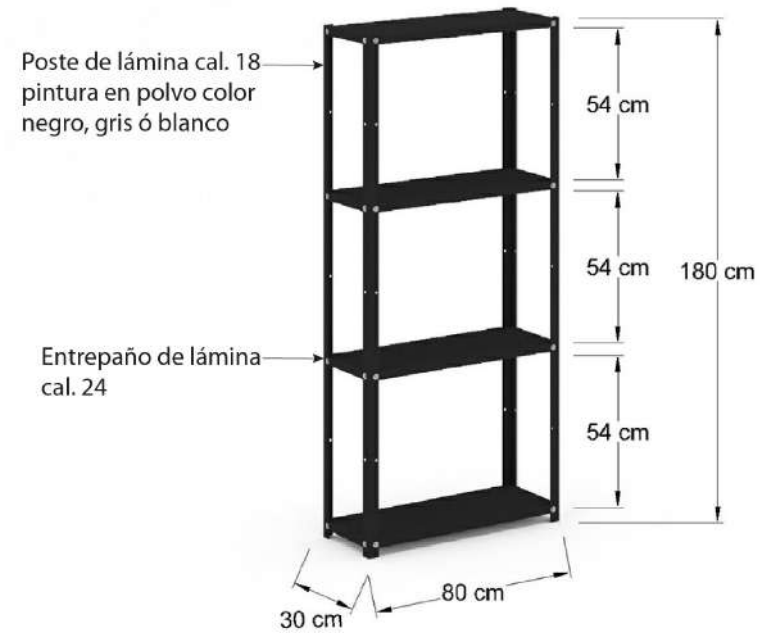

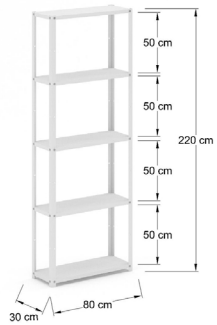

EEC220

Estante metálico de 5 entrepaños, postes en lámina cal 18 y entrepaños en lámina cal 24 terminado en pintura color negro, gris ó blanco, capacidad de carga de 50 kg por entrepaño, medida: 80x30x220cm.

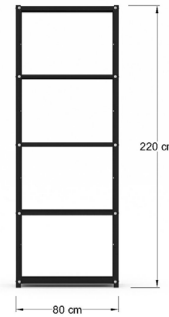

EEC180

Estante metálico de 4 entrepaños, postes en lamina cal 18 y entrepaños en lámina cal 24 terminado en pintura color negro, gris o blanco, capacidad de carga de 50 kg por entrepaño, medida 80x30x180cm.

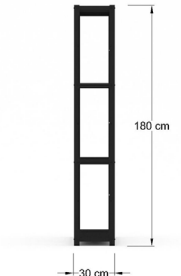
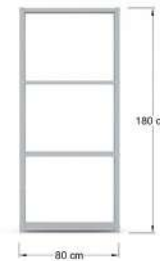

Capacidad de carga de 100 kg por entrepaño.

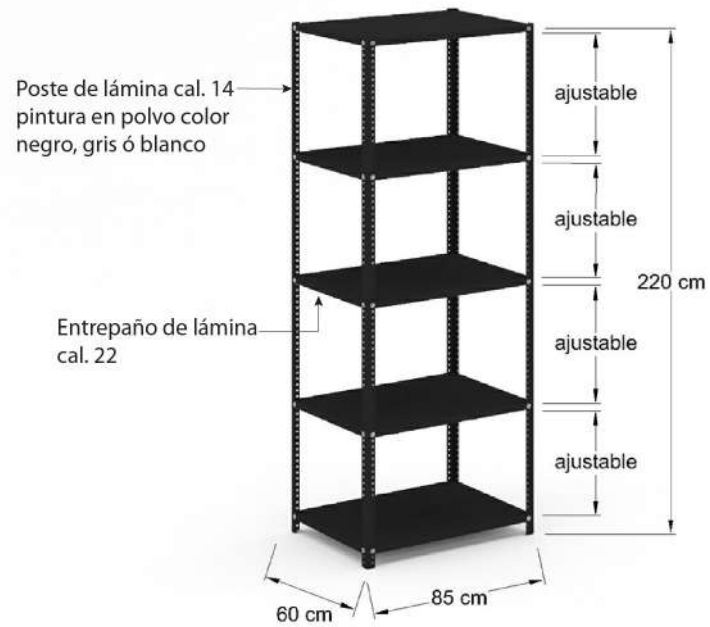
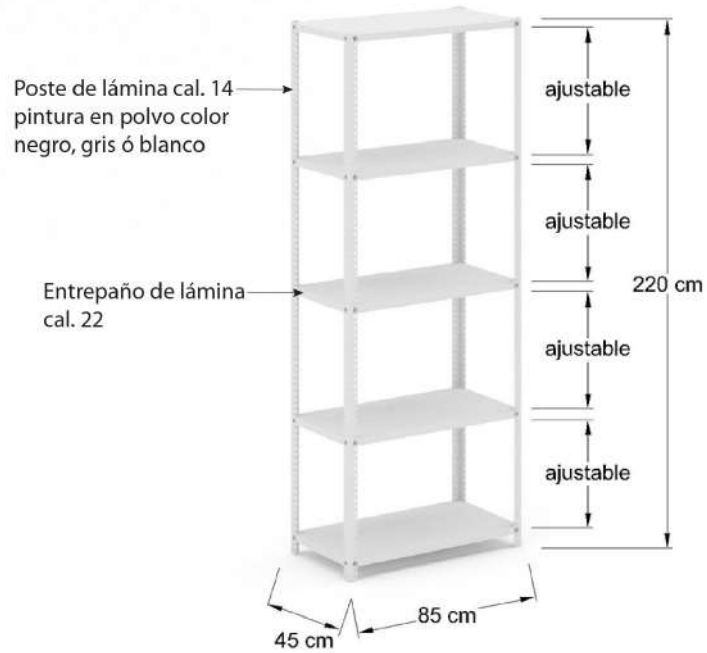

85 x 30 x 220 de 4 y 5 entrepaños

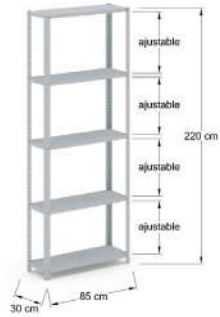

ELI3022

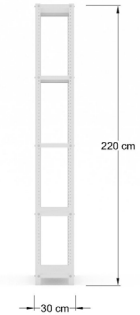
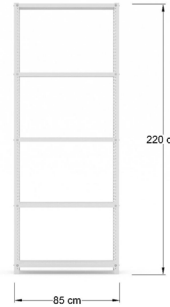

Estante metálico de 5 entrepaños, postes en lámina cal 14 y entrepaños en lámina cal 22 terminado en pintura color negro, gris ó blanco, capacidad de carga de 100 kg por entrepaño, medida:85x30x220cm.

85 x 45 x 220 de 4 y 5 entrepaños

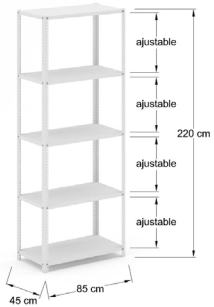

ELI4522

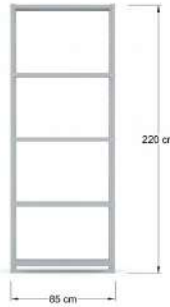

Estante metálico de 5 entrepaños, postes en lamina cal 14 y entrepaños en lámina cal 22 terminado en pintura color negro, gris ó blanco, capacidad de carga de 100 kg por entrepaño, medida 85x45x220cm.

85 x 60 x 220 de 4 y 5 entrepaños

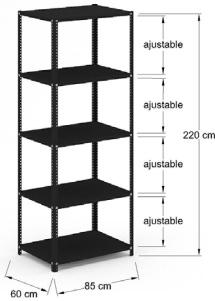

ELI6022

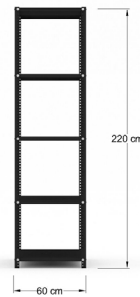
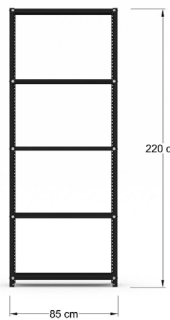

Estante metálico de 5 entrepaños, postes en lamina cal 14 y entrepaños en lámina cal 22 terminado en pintura color negro, gris ó blanco, medida: 85x60x220cm.

85 x 30 x 220 de 4 y 5 entrepaños



ELI3022-C



Estante metálico de 4 entrepaños, postes en lámina cal 14 y entrepaños en lámina cal 22 terminado en pintura color a elegir, capacidad de carga de 100 kg por entrepaño, medida:85x30x220cm.

85 x 45 x 220 de 4 y 5 entrepaños



ELI4522-C



Estante metálico de 5 entrepaños, postes en lamina cal 14 y entrepaños en lámina cal 22 terminado en pintura color color a elegir, capacidad de carga de 100 kg por entrepaño, medida 85x45x220cm.

85 x 60 x 220 de 4 y 5 entrepaños



ELI6022-C



Estante metálico de 5 entrepaños, postes en lamina cal 14 y entrepaños en lámina cal 22 terminado en pintura color a elegir, capacidad de carga de 100 kg por entrepaño, medida: 85x60x220cm.

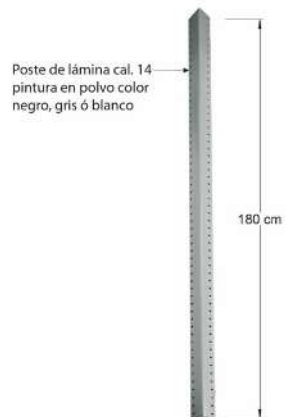
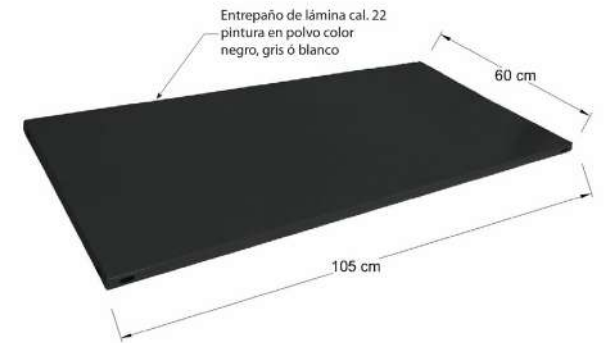
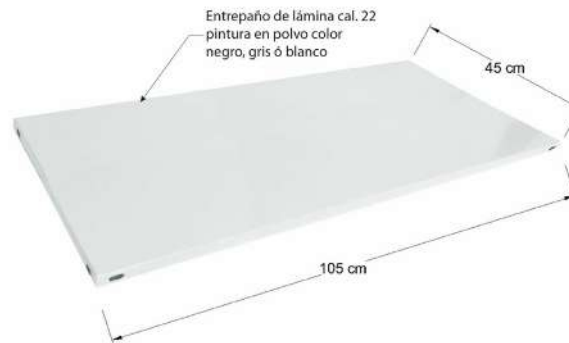
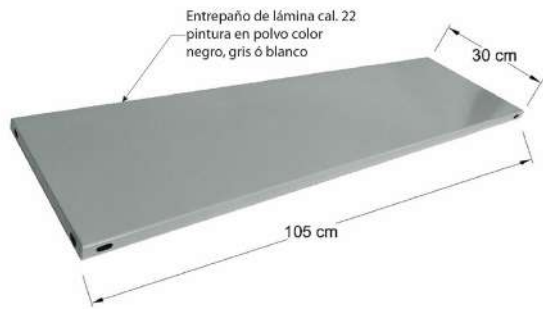
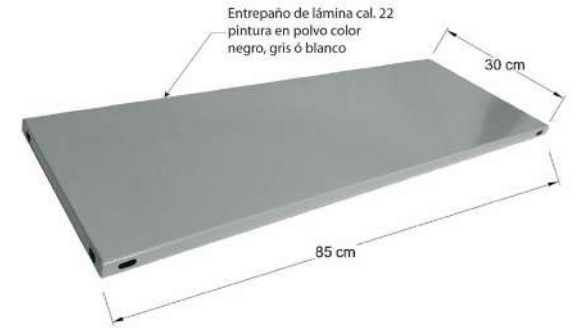

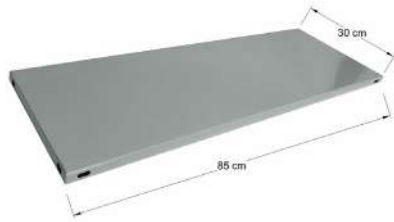

AES1



Entrepaño de 85 de frente x30cm de fondo, fab. en lamina cal. 22,ranurado para tornillo de $\frac{1}{4}$ x $\frac{1}{2}$,

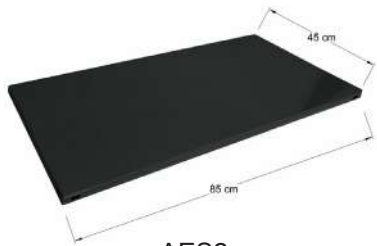

AES2



Entrepaño de 85 de frente x45cm de fondo, fab. en lamina cal. 22,ranurado para tornillo de $\frac{1}{4}$ x $\frac{1}{2}$



AES3



Entrepaño de 85 de frente x60cm de fondo, fab. en lamina cal. 22, ranurado para tornillo de $\frac{1}{4}$ x $\frac{1}{2}$.

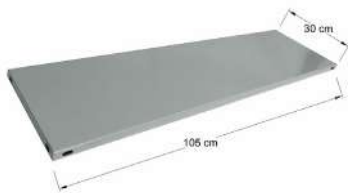

AES4



Entrepaño de 105 de frente x 30cm de fondo, fab. en lamina cal. 22,ranurado para tornillo de $\frac{1}{4}$ x $\frac{1}{2}$

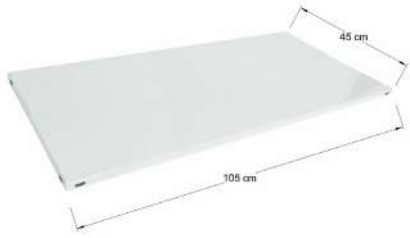

AES5

Entrepaño de 105 de frente x45cm de fondo, fab. en lamina cal. 22,ranurado para tornillo de ¼ x ½.

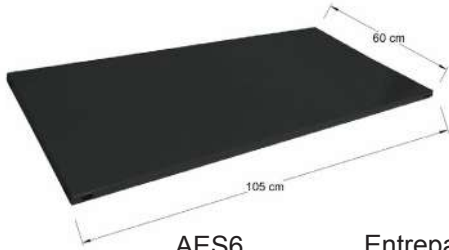

AES6

Entrepaño de 105 de frente x60cm de fondo, fab. en lamina cal. 22,ranurado para tornillo de ¼ x ½.

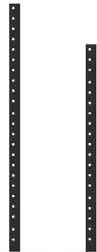

APO2

Poste de 220cm de alto, fabricado en lámina clibre 14.

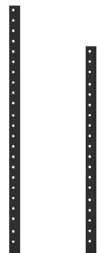
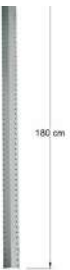

APO3

Poste de 180cm de alto, fabricado en lámina clibre 14.



Capacidad de carga de 70 kg por entrepaño.

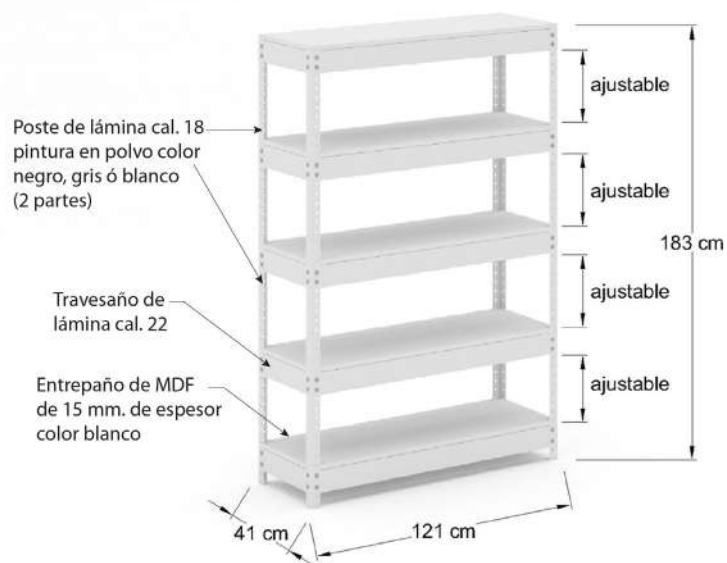
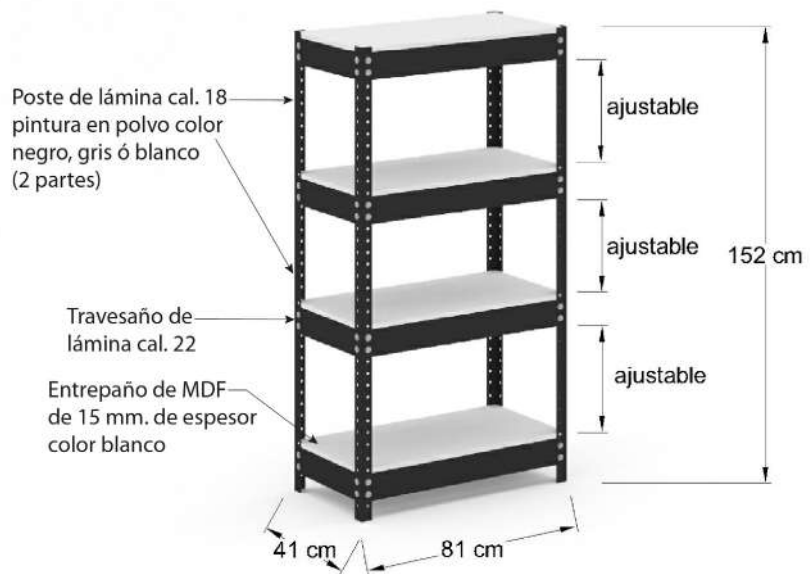

Configuración horizontal

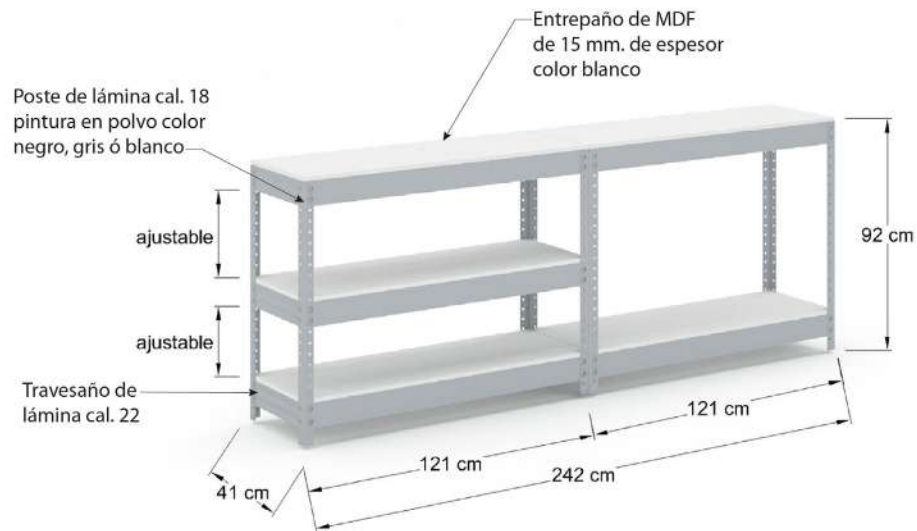



AMDF8381

Estante metálico de 5 entrepaños, postes en lámina cal 18 y travesaños en lámina cal 22 con entrepaño en MDF de 15mm en color blanco terminado en pintura color negro, gris ó blanco, capacidad de carga de 70kg por entrepaño, medida: 81x41x183cm.



AMDF5281

Estante metálico de 4 entrepaños, postes en lámina cal 18 y travesaños en lámina cal 22 con entrepaño en MDF de 15mm en color blanco terminado en pintura color negro, gris ó blanco, capacidad de carga de 70 kg por entrepaño, medida: 81x41x152cm.



AMDF5221

Estante metálico de 4 entrepaños, postes en lámina cal 18 y travesaños en lámina cal 22 con entrepaño en MDF de 15mm en color blanco terminado en pintura color negro, gris ó blanco, capacidad de carga de 70 kg por entrepaño, medida: 121x41x152cm.



Estante metálico de 5 entrepaños, postes en lámina cal 18 y travesaños en lámina cal 22 con entrepaño en MDF de 15mm en color blanco terminado en pintura color negro, gris ó blanco, capacidad de carga de 70 kg por entrepaño, medida: 121x41x183cm

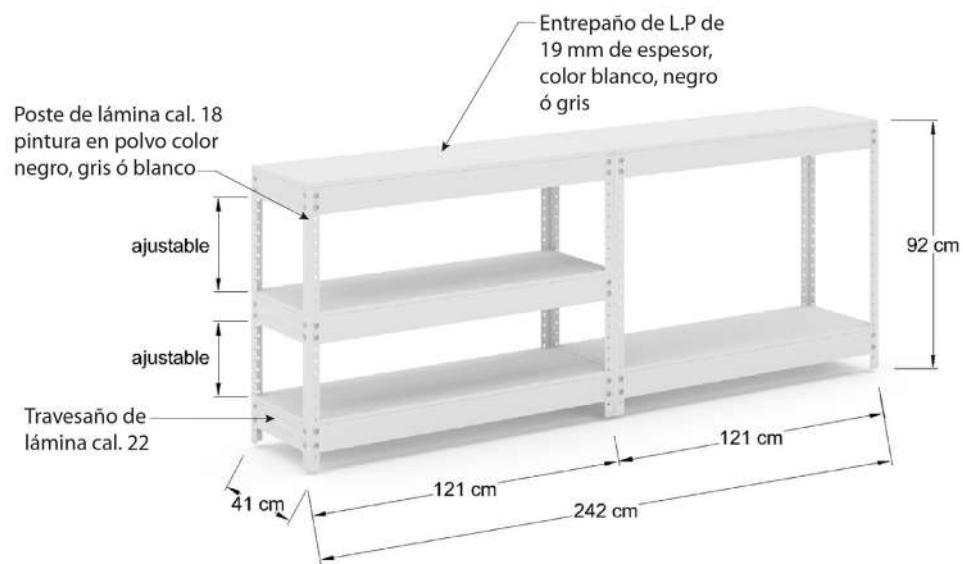
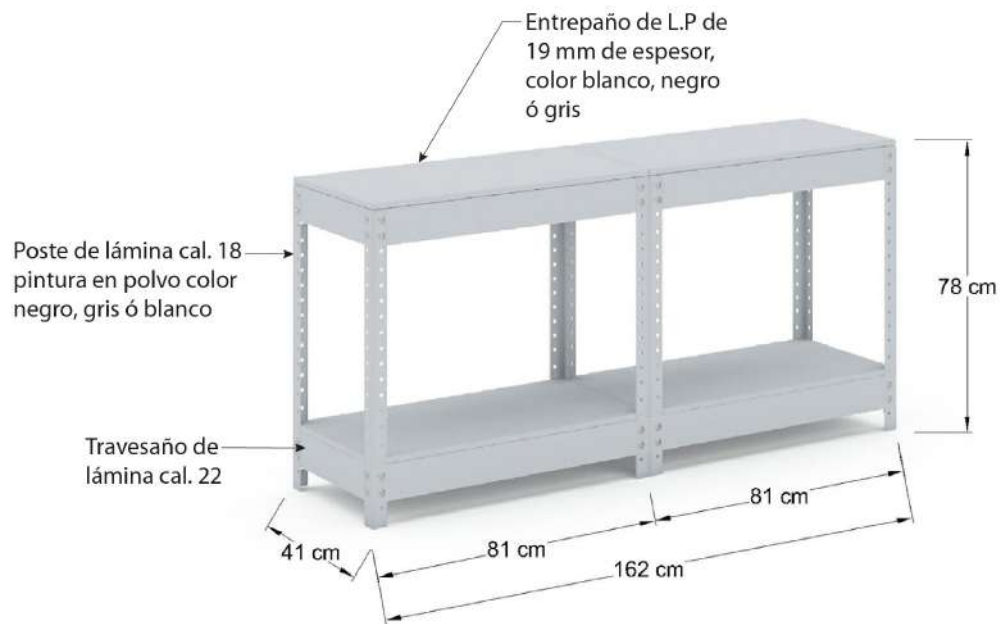

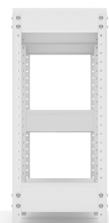
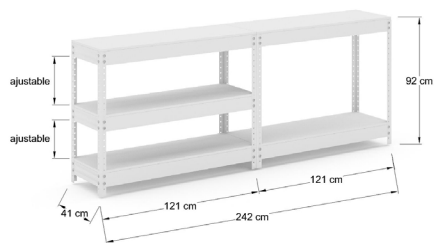

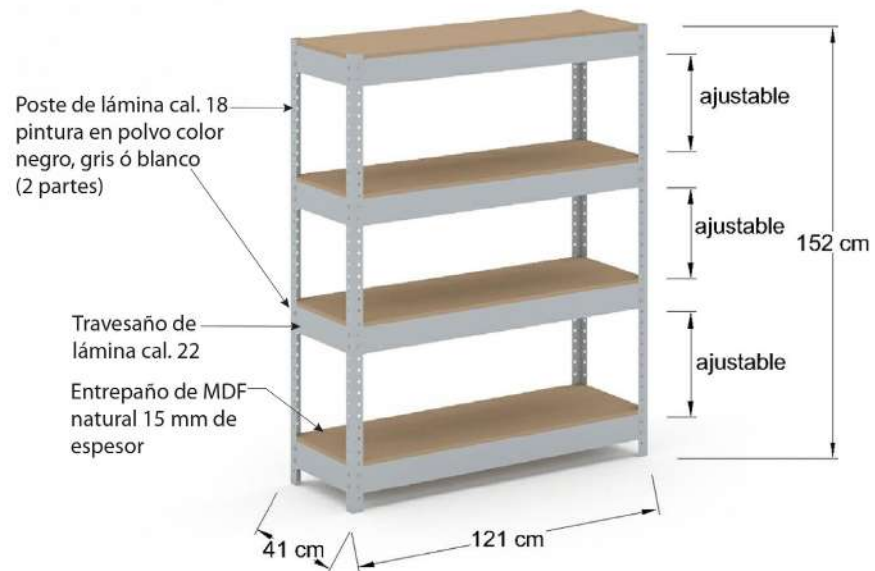

Configuración horizontal





ANMD9152

Estante metálico de 4 entrepaños, postes en lámina cal 18 y travesaños en lámina cal 22 con entrepaño en MDF natural de 15mm en colores de línea terminado en pintura color negro, gris ó blanco, medida: 81x41x152cm.



ANMD9183

Estante metálico de 5 entrepaños, postes en lámina cal 18 y travesaños en lámina cal 22 con entrepaño en MDF natural de 15mm en colores de línea terminado en pintura color negro, gris ó blanco, medida: 81x41x183cm.



ANMD2183

Estante metálico de 4 entrepaños, postes en lámina cal 18 y travesaños en lámina cal 22 con entrepaño en MDF natural de 15mm en colores de línea terminado en pintura color negro, gris ó blanco, medida: 121x41x152cm.



Estante metálico de 5 entrepaños, postes en lámina cal 18 y travesaños en lámina cal 22 con entrepaño en MDF natural de 15mm en colores de línea terminado en pintura color negro, gris ó blanco, medida: 121x41x183cm.

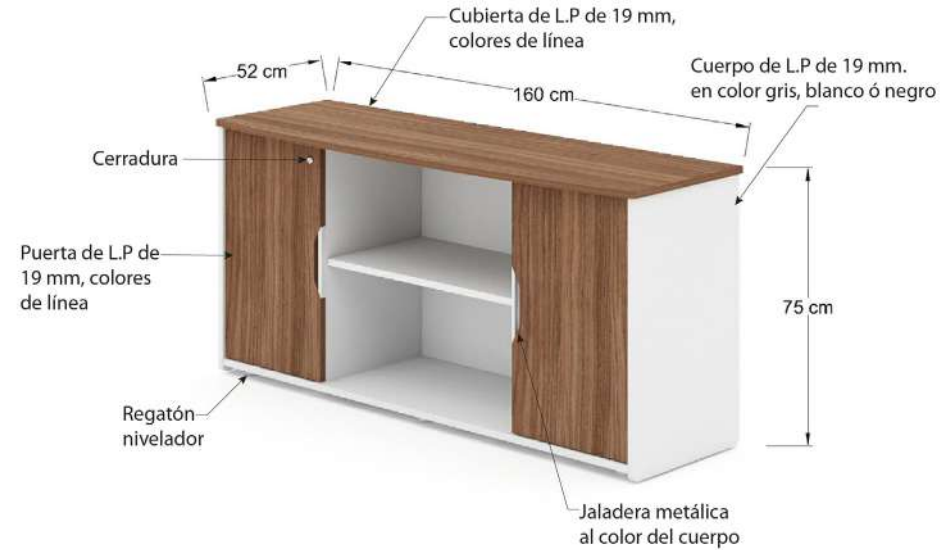
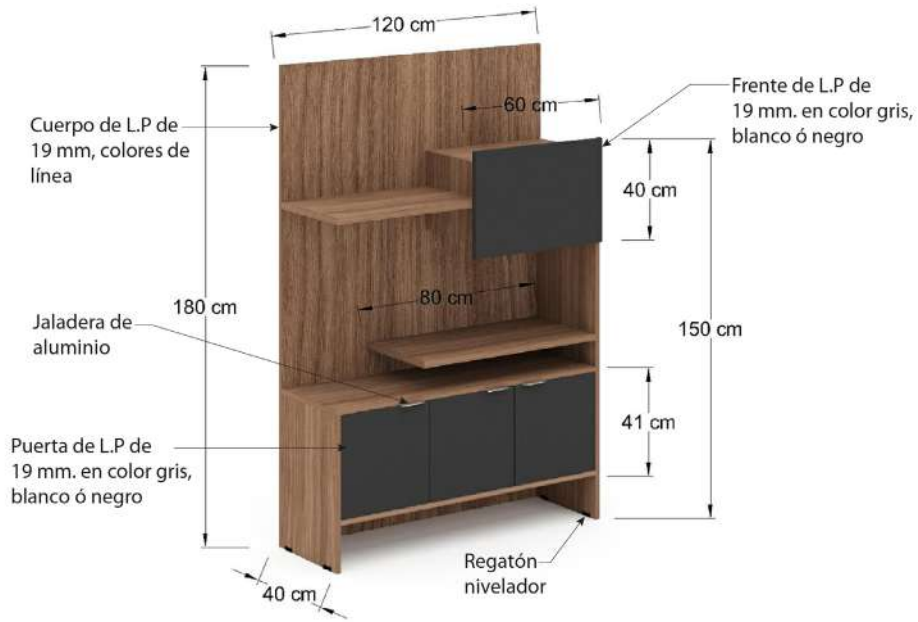



LKO12

Librero de 120x40x180.



FCR14

Credenza de la línea express. medidas: 160 cm, fondo: 52 cm, altura: 75 cm.



FCE16

Credenza de la línea express. medidas: 160 cm, fondo: 52 cm, altura: 75 cm.



FGA51

Gaveta multiusos, medidas: frente: 51 cm, fondo: 60 cm, altura: 100 cm.





MCREP12

Módulo lateral de L.P. en 19mm de espesor de 120x40x63 incluye chapa.



MCRE12

Módulo lateral de L.P. en 19mm de espesor de 120x40x63.



MCR2P12-I

Módulo lateral de L.P. en 19mm de espesor de 120x40x63 con dos puertas del lado izquierdo, incluye chapa



MCR2P12-D

Módulo lateral de L.P. en 19mm de espesor de 120x40x63 con dos puertas del lado derecho, incluye chapa



